



# WHILL Model Ci

## User Manual



en-Gen



# Introduction

Thank you for your purchase of the WHILL Model Ci!

This User Manual is intended for users of this device and instructs how to safely operate device. It also explains the basic adjustments, inspections, troubleshooting, and the basic maintenance procedures that are performed by the user.

This manual can also be used by distributors, agents, sales staff, and others in order to gain a detailed understanding of the main functions.

This manual uses text, diagrams, and standard terms to explain the different components of the device.

WHILL is dedicated to helping ensure the safety, comfort, and convenience of the users. Please read this manual carefully before use, and be sure to use the device correctly and safely. Store this manual in a location where it can be referred to whenever needed.

- This manual contains information that is protected by patent rights and copyrights. It may not be reproduced in part or in whole without explicit written permission from WHILL, Inc.
- The contents of this manual may be changed in the future without notice.
- Use of this device in ways not consistent with the contents of this manual may result in damage to the device.

Let us know at [support@whill.us](mailto:support@whill.us) if you notice any inaccuracies or omissions in this manual!



## ■ Trademarks

- Apple, iPhone, and iPad are registered trademarks of Apple Inc. in the United States and other countries. AppStore is a service mark of Apple Inc.
- The iOS trademark is used based on a license from the U.S. company Cisco Systems, Inc.
- Other company names and device names are the trademarks or registered trademarks of their respective companies.
- Company trademarks and registered trademarks in this text are not indicated by the <sup>TM</sup> or ® symbols.





# Manual Overview

This manual uses symbols such as those shown below to explain the device. Be sure to observe the instructions indicated by each symbol.

## ■ Warning indications

Symbol	Description
 <b>WARNING</b>	Indicates instructions which, if not observed, may result in serious injury.
 <b>CAUTION</b>	Indicates instructions which, if not observed, may result in minor or moderate injury or in property damage.

## ■ Symbol mark indications

Symbol	Description
	Indicates a prohibited act.
	Indicates that disassembly of the device may result in electric shock or other injury.
	Indicates a required act.
	Indicates a risk of electric shock.
	Indicates a risk of rupture.

## ■ Other indications

Symbol	Description
	Indicates precautions or reference information that must be read in order to prevent device malfunctions or failures, and to ensure comfortable device use.

# Contents

<b>Introduction .....</b>	<b>1</b>
<b>Manual Overview .....</b>	<b>2</b>
<b>1. Safety Precautions .....</b>	<b>7</b>
1.1. Precautions for Use.....	22
1.2. EMI (Electromagnetic Interference) .....	22
1.2.1. General Q&A.....	23
1.3. Location of Warning Labels.....	24
1.3.1. Label types .....	24
1.3.2. Label application locations.....	27
1.4. Location of Serial Number.....	30
<b>2. About This Device .....</b>	<b>31</b>
2.1. Checking the Contents.....	31
2.2. Names and Functions of Parts.....	31
2.3. Accessories .....	36
<b>3. Charging the Battery .....</b>	<b>37</b>
3.1. Battery Components .....	39
3.2. Charging Procedure .....	40
3.2.1. Charging with the battery installed in the base .....	42
3.2.2. Charging with the battery removed .....	43
3.2.3. Power/charge indicator indications .....	46
3.3. Checking the Charge Level of the Removed Battery .....	46
3.3.1. Charge level indicator error indication.....	47
3.4. Battery Inspection and Replacement .....	48
<b>4. Operating Procedures .....</b>	<b>49</b>
4.1. Inspection Before Getting into the Device .....	50
4.2. Getting into the Device.....	52
4.2.1. Accessing the seat from the front .....	53
4.2.2. Accessing the seat from the side .....	54
4.3. Fastening the Lap Belt (If purchased) .....	55

4.4.	Turning On the Power .....	56
4.4.1.	Checking the battery charge level .....	57
4.4.2.	Adjusting the maximum speed .....	58
4.4.3.	Using the horn .....	58
4.5.	Driving .....	59
4.5.1.	Moving forward and backward .....	62
4.5.2.	Moving in a diagonal direction.....	62
4.5.3.	Turning.....	63
4.5.4.	Stopping .....	63
4.5.5.	Controlling the speed .....	64
4.5.6.	Driving under different road conditions .....	65
4.6.	Releasing the Brakes.....	66
4.6.1.	Release procedure.....	66
4.7.	Storage Basket.....	67
4.8.	Locking the Device.....	69
4.8.1.	Locking .....	69
4.8.2.	Unlocking.....	70
4.9.	Using the USB port .....	71
<b>5.</b>	<b>Assembly, Adjustment, and Disassembly .....</b>	<b>73</b>
5.1.	Component List.....	73
5.2.	Assembly Procedures .....	75
5.2.1.	Assembling the Front drive base and Rear drive base.....	76
5.2.2.	Installing the storage basket.....	77
5.2.3.	Installing the seat assembly.....	78
5.2.4.	Installing the battery .....	81
5.3.	Adjustment Procedures.....	82
5.3.1.	Adjusting the arm length.....	83
5.3.2.	Switching the left and right sides of the directional controller assembly and control pad .....	84
5.3.3.	Adjusting the seat height .....	89
5.3.4.	Adjusting the back support height.....	92
5.3.5.	Adjusting the back support angle.....	93

5.4. Disassembly Procedures.....	94
5.4.1. Removing the battery .....	95
5.4.2. Removing the seat assembly.....	96
5.4.3. Removing the storage basket.....	98
5.4.4. Removing the Front drive base.....	99
<b>6. Transport and Storage Methods.....</b>	<b>101</b>
6.1. Storage.....	101
6.2. Transport.....	102
6.2.1. How to hold each component .....	103
<b>7. Downloading the Smartphone App .....</b>	<b>105</b>
<b>8. Maintenance and Inspection .....</b>	<b>107</b>
8.1. User Maintenance .....	107
8.2. Replacing the Smart Key Battery .....	108
8.3. Reinstalling the Controller Knob.....	109
8.4. Inspection.....	110
8.5. Repairs, Maintenance, and Parts Replacement Performed by the Manufacturer or Distributor.....	110
8.6. Disposal.....	111
<b>9. Troubleshooting.....</b>	<b>113</b>
<b>10. Specifications and Test Results.....</b>	<b>115</b>
10.1. Specifications.....	115
10.2. Dimentions .....	117
<b>Index .....</b>	<b>119</b>
<b>About the Warranty .....</b>	<b>121</b>
<b>Contact Information .....</b>	<b>122</b>





# 1. Safety Precautions

Complete attention to safety has been given in the design of the device. However, there is a risk of injury or damage to property as a result of incorrect use of the device or as a result of a failure to observe precautions. Before using this device, carefully read the following safety-related information and be sure to use the device correctly.

The descriptions related to safety use the terms “WARNING” and “CAUTION” to indicate the degree of injury or damage and the level of imminence.

## WARNING



- **If you sense anything abnormal during use, immediately discontinue use and contact your distributor or WHILL Customer Support.**  
Continuing to use the device when there is a malfunction may have adverse effects on health.
- **Persons who have an implanted pacemaker, implanted defibrillator, or other electrical medical device on their bodies must stay a minimum of 8 inches (20 cm) away from the magnetic connectors.**  
The magnetic connectors are located at the connection between the seat assembly and rear drive base, and the connection between the battery and rear drive base. The charge of the magnetic connectors may have an adverse effect on electrical medical devices.
- **Persons who have an implanted pacemaker, implanted defibrillator, or other electrical medical device on their bodies must stay a minimum of 6 inches (15 cm) away from the control pad.**  
There is a risk of an adverse effect on electrical medical devices.
- **Turn off the device power when not operating.**  
There is a risk of accidental contact with the controller knob causing unexpected movement of the device.
- **When using the device for the first time, be sure to check the device for damage before using it.**  
If the device is damaged, there is a risk of an unexpected accident.

 **WARNING****● Be sure to check the following before getting into the device.**

There is a risk of unexpected accident.

- Check that the brakes are not released.
- Check that the anti-tip bar is lowered.

**● Check that the release levers are locked before getting into the device.**

If the release levers are not locked, there is a risk of the device coming acomponent during use. If it is not possible to lock the release levers, immediately discontinue use and contact your distributor.

**● Turn off the device power when getting into and out of the device.**

There is a risk of unexpected movement of the device caused by accidental contact with the controller knob.

**● Lock the brakes before getting into the device.**

If the brakes are released, there is a risk that the device may start moving and tip over.

**● If your body is not stable in the seat, be sure to use the lap belt (if purchased).**

There is a risk of falling out of the device. If the device you are using does not have a lap belt, contact your distributor.

**● When operating the device while wearing gloves, be careful that the gloves do not become caught.**

There is a risk that gloves may become caught in control components, resulting in incorrect control.

**● Pay attention to the following while driving.**

There is a risk of unexpected accident.

- Fully check the surroundings and road conditions before driving.
- Do not drive the device onto escalators or stairs.
- Do not attempt to ascend or descend steps that are more than 2 inches (50 mm) high.
- When driving at night or in places with poor visibility, check that the rear tail light is visible to other persons before using the device.

 **WARNING**

- **Be sure to drive carefully at low speed in cases when particular caution is necessary, such as in crowds of people, close to walls, or other locations where there are obstacles nearby, and in narrow places.**  
There is a risk of collision and tipping over.
- **When approaching curbs, steps, slopes, and similar obstacles, approach at a 90° angle and drive over them carefully at low speed.**  
There is a risk of tipping over or causing deformation of the base.
- **Drive carefully at low speed when driving on roads that are not flat or on slopes.**  
There is a risk of tipping over.
- **When driving, take care that the wheels do not contact your body or those of the people around you.**  
There is a risk of injury.
- **When stopping on a downhill slope, release the controller knob early and make sure that you stop with a sufficient margin of extra space.**  
The brake stopping distance is longer when on a downhill slope. There is a risk that you may be unable to stop in the intended position, causing an unexpected accident.
- **Be sure to turn Off the power before releasing the brakes.**  
There is a risk that the device may start moving, causing an unexpected accident.
- **Release the brakes only in emergencies. Do not leave the brakes released for an extended period of time.**  
When the brakes are released, the device will move freely. This is extremely dangerous.
- **After moving the device manually with the brakes released, be sure to raise the brake release levers and lock the brakes.**  
There is a risk of unexpected accident.
- **Be sure to use the storage basket when carrying any items. Be sure that the items does not exceed the storage basket reference level height.**  
There is a risk of tipping over.

 **WARNING**

- **Be sure to disassemble the device before lifting it up.**  
The weight of the device is approximately 115 lbs (52 kg). If it is lifted up without disassembly, there is a risk of injury to the user, and/or damage to the device.
- **Be careful of the weight when lifting up each component.**  
There is a risk of injury to the user, and/or to the device.
- **When moving the arm up or down in order to adjust the arm length or for other reason, be careful that your fingers do not become caught.**  
There is a risk of injury.
- **When moving the foot rest up and down, be careful that your fingers do not become caught at the hinge.**  
There is a risk of injury.
- **When moving the back support up or down in order to adjust the back support height or for other reason, be careful that your fingers do not become caught in the bottom of the back support or the connection.**  
There is a risk of injury.
- **When assembling or disassembling the front drive base and rear drive base, be sure to grasp the handle A.**  
There is a risk of injury caused if fingers are caught.
- **Perform assembly and disassembly in a flat, level location.**  
There is a risk of unexpected accident.
- **Be sure to replace the anti-tip bar if it gets deformed.**  
There is a risk that it may lose its tip-over prevention function and device may tip over.
- **Be sure to remove the battery before performing adjustment or disassembly.**  
There is a risk of unexpected device movement. In addition, if the device is disassembled without the battery removed, there is a risk that the device may be reset due to metal contact with exposed connectors. If the device is reset, disconnect the battery and then reconnect it.
- **Before use, check that all components are properly assembled and that there are no missing or broken components.**  
If there is a missing or broken component, accident or malfunction may occur during use.

## ⚠ WARNING



- **The maximum load weight for this device is 253 lbs (115 kg). Do not subject it to a load higher than this limit.**  
There is a risk of damaging the device.
- **Never release the brakes when on a slope. Be sure to release the brakes only when in a flat surface.**  
There is a risk that the device may start moving, causing an unexpected accident.
- **Do not apply stickers or paint onto the rear tail light, switches, display, or labels.**  
There is a risk that these components may not be visible, resulting in incorrect operation and unexpected accident.



- **Do not touch the battery connectors, allow them to become wet , or bring any metal or other foreign objects close to them.**  
There is a risk of injury and of damage to the device or its components.
- **Do not remove the motor controller connectors and caps.**  
There is a risk that a short circuit may occur by intrusion of foreign objects, or the device may become inoperable due to incorrect reassembly.

Motor controller connector

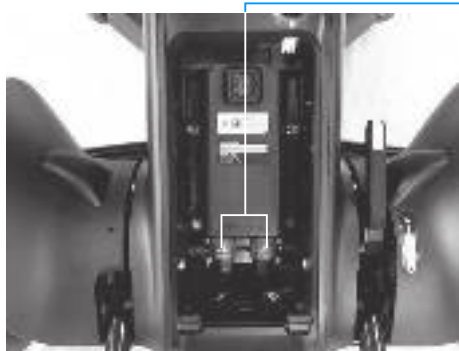

Battery component

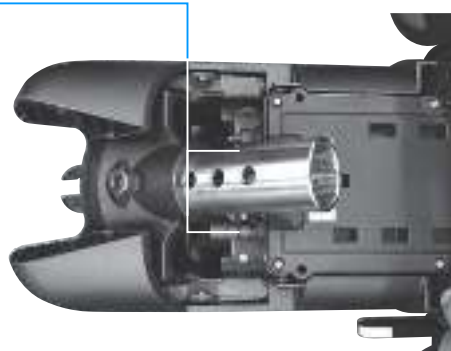

Next to rear drive base seat post

- **Do not directly touch the grease that comes from the wheels.**  
There is a risk of harmful effect on the skin.

 **WARNING**

- **While driving the device, do not crouch down or lean your body outside the chair. Be careful of moving the center of gravity while driving.**

There is a risk of affecting the device stability and balance. If you are unsure about the device stability, request help from people around you in order to stabilize the Device.

- **Do not lean on the back support from behind the device.**

There is a risk that the back support may tilt forward, causing you to lose your balance and fall over.

- **Do not use the device if any of the components are damaged.**

There is a risk of injury caused by sharp corners or edges. For replacement of components, consult with your distributor or manufacturer.

- **Avoid operating the device when wearing clothing or other items that can easily be caught in the rotating component of the arm, wheels, or other moving component.**

There is a risk that clothing may be caught in these components, preventing you from controlling the device.

- **Do not sit on the controller knob, place the removed seat assembly upside down, or apply an excessive load to the controller knob.**

There is a risk that the controller knob may be damaged, rendering the device inoperable.

- **Do not press the buttons with strong force or using a sharp object.**

There is a risk that the control pad may be damaged, rendering the device inoperable.

- **Do not apply the weight of your body to the control pad, controller knob, or accessory bar.**

There is a risk that these components may become disconnected, rendering the device inoperable.



- **Do not jump onto the foot rest, step onto the foot rest while carrying a heavy object, or otherwise place an excessive load on the foot rest.**

There is a risk of the device being lifted up and tipping.

- **Do not take your feet off of the foot rest while driving.**

There is a risk that your feet may become caught in moving components. Keep your feet on the foot rest while driving.

 **WARNING**

- **Do not drive with the foot rest raised.**  
There is a risk that your feet may become caught in moving components.
- **Do not drive while holding something in your hand or with something placed on your lap.**  
There is a risk of incorrect operation and tipping over.
- **Do not drive on a soft surface, such as sand or mud.**  
There is a risk of the device becoming stuck.
- **Do not drive through puddles or in standing water.**  
There is a risk of corrosion and short circuit.
- **Do not extend arms, legs, or any belongings outside of the device.**  
There is a risk of injury caused by collision while driving.
- **Do not tow cargo.**  
There is a risk of tipping over.
- **Do not perform any disassembly, adjustments, or repair that is not explained in this manual.**  
If the customer performs such acts him/herself, there is a risk of a serious effect on safety.  
Consult with your distributor when adjusting the seat length or arm position.
- **Do not disassemble, adjust, or repair the device, or lift the device up while it's in use.**  
There is a risk of damage to the device, causing an unexpected accident.
- **Do not use the device as a seat in an automobile or other vehicle.**  
There is a risk of damage to the device, causing an unexpected accident.



- **Do not modify the device or its accessories.**  
If repair or modification which is not listed in this manual is performed, the warranty may be voided.



- **When using the device, it is recommended that you carry a mobile phone or other communications device with you as a means of communication.**  
Without such a device, there is a risk that you may be unable to call for help in the event of an accident.

 CAUTION

	<ul style="list-style-type: none"> <li>● <b>If a component is lost, immediately discontinue use and contact your distributor or manufacturer.</b> There is a risk of damage to the device that renders it inoperable.</li> </ul>
	<ul style="list-style-type: none"> <li>● <b>Be sure to install the cap when the battery charging port or USB port is not in use.</b> There is a risk of short circuit caused by intruding foreign objects.</li> <li>● <b>When connecting the USB cable, check that there are no foreign substances in the connector.</b> Charging is not possible when there is a foreign substance caught in the connector.</li> <li>● <b>Be sure to install the protective cap when the USB port is not in use.</b> If corrosion of the USB terminal occurs due to the intrusion of water or other substance, charging will not be possible.</li> <li>● <b>When using your own cushion, for safety, be sure to use a cushion that has passed a fire-resistance test.</b></li> <li>● <b>If the power does not turn on, check the magnetic connectors.</b> The magnetic connectors are located at the connection between the seat assembly and rear drive base, and the connection between the battery and rear drive base.</li> <li>● <b>Pay attention to the following while driving.</b> There is a risk of unexpected accident.             <ul style="list-style-type: none"> <li>• Check that the arm is locked before beginning operation.</li> <li>• Reduce speed when driving on a slope.</li> </ul> </li> <li>● <b>When driving on uneven roads, drive at low speeds.</b> There is a risk of accidentally causing unexpected operation.</li> </ul>
	<ul style="list-style-type: none"> <li>● <b>On roads, drive on the sidewalk.</b> This device is not designed for use on automobile roadways, snow-covered roads, or frozen roads. When crossing roads, check that the drivers can see you and exercise sufficient caution while crossing.</li> </ul>



 **CAUTION**

- **When moving the device after releasing the brakes, push it by hand and move it slowly.**  
When the brakes are released, the device will move freely. Pushing it forcefully may cause it to move in an unexpected direction.
  - **Pay attention to the following when using the storage basket.**  
There is a risk of unexpected accident.
    - Turn the power off before putting objects in or taking them out of the storage basket.
    - When removing objects from the basket, check that the hook has been disconnected from the accessory bar.  
Connect and disconnect the hook by hand.
  - **When assembling, adjusting, disassembling, and transporting the device, grasp only the parts that are explained in this manual, and do not hold the device by any other components.**  
There is a risk of injury caused when a hand gets caught in the device.
  - **When assembling, check that the magnetic connectors are not dirty.**  
If a magnetic connector is dirty, electricity may not flow through it, and the power may not turn on. The magnetic connectors are located at the connection between the seat assembly and rear drive base, and the connection between the battery and rear drive base.
- 
- **Pay attention to the following and perform adjustment in order to ensure safe use.**  
There is a risk of unexpected accident.
    - Be sure to adjust the device to match the user's body before using it.
    - When adjusting, be sure to retighten the bolts.
    - Be sure to exit the device before performing adjustment.
    - Before performing adjustment, be sure to remove the battery from the device.
- 
- **Before driving, check that the storage basket hook is connected to the accessory bar.**  
There is a risk of stored objects falling out during driving.
  - **Store the Model Ci in a flat location.**  
There is a risk of damage to the device.

 **CAUTION**

- **When boarding an airplane, notify the airline company in advance that you will be using a powered device, receive an explanation of the boarding procedure, and follow the instructions of the airline company.**  
Failure to notify the airline in advance may result in additional time required for the boarding procedure.
  - **Fasten securely when placing in an automobile trunk or similar location.**  
There is a risk of damage to the device.
  - **When using a forklift to transport this device, be sure to fasten the device securely.**  
There is a risk of the device falling, causing damage to the device.
  - **If a component gets worn or requires replacement, contact your distributor or manufacturer.**  
There is a risk of damage to the device that renders it inoperable.
  - **When disposing of the device and its components, be sure to follow the rules of the local municipality.**  
If there is anything that is unclear, consult your distributor or WHILL Customer Support.
  - **Device battery should be charged in a well-ventilated space that is free of flammable gases and that is at least twice the size of the device.**  
There is a risk of explosion or other accident if the space is filled with flammable gas or if ventilation is insufficient.
- 
- **Do not place the battery or the device in a location that is inclined, in a location where there is much vibration, on a high shelf, or in a similar place.**  
There is a risk of damage to or deformation of the battery or device.



**⚠ CAUTION**

- **Do not touch the motor controller connectors. Do not use excessive force or speed when removing or installing the battery.**

There is a risk of damage to the battery, motor, and other components of the device.

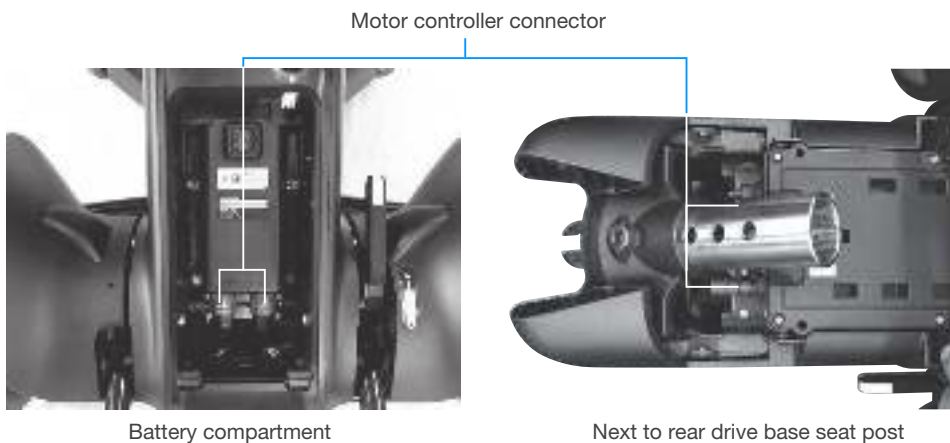

- **Do not place a load on the directional controller assembly or scratch it with a sharp object.**  
There is a risk that the directional controller assembly may become damaged, rendering the device inoperable.
- **Do not throw, step on, or otherwise subject the removed control assemblies to strong impact, and or immerse them in water.**  
There is a risk that the switch or directional controller assembly may become damaged, rendering the device inoperable.
- **Do not scratch the display or touch it with dirty hands.**  
There is a risk that the display information may get unreadable.



**CAUTION**

- **Do not apply stickers to the speaker or otherwise block the speaker.**  
There is a risk that you may be unable to hear the guidance messages and sounds.
- **Do not apply force to the device from the sides.**  
There is a risk that the device may flip. Do not forcefully push or pull the device from the side.
- **Do not sit or place any objects on the arm or arm rest.**  
There is a risk that the arm rest may get deformed or damaged.
- **Do not place a heavy object on the back support.**  
The back support maximum load is 10 lbs ( 5 kg). If a larger load is applied to it, the back support may be damaged.
- **When adjusting the seat height, do not pull forcefully on the seat post.**  
There is a cable inside the seat post. Pulling forcefully on the seat post may break the cable inside it.
- **Do not press a sharp object against or apply a load to the seatback cables located on the bottom of the seat.**  
There is a risk of breaking the cables.









- **Do not store the device for long periods in a location where there is much dust or sand, near the ocean, or in a hot spring area.**  
There is a risk of foreign substances entering the device and corroding the frame and screws.
- **Do not store the device with a heavy object placed on it for a long period of time.**  
There is a risk of device malfunction.
- **Do not store the device or the storage basket outdoors in a location exposed to direct sunlight or rain.**  
There is a risk that rain may cause a short circuit, and that direct sunlight may cause deformation or deterioration of the device or storage basket. The device and any accessories must be stored in a covered location.



 **CAUTION**

- Do not use paint thinner, benzene, or other organic solvents for cleaning, and do not use a high-pressure washer.  
Doing so may result in discoloration, deformation, deterioration, and damage.
  - Do not insert a sharp object into the speaker holes.  
Doing so may damage the control pad.
  - Do not disassemble the control assemblies.  
Doing so may cause malfunction of the control assemblies.
  - Do not remove the labels.  
The labels contain important information.
  - Do not attempt to grease the moving components or connectors of the Device.  
There is a risk that the stickiness of such substances may cause sand or other foreign substance to enter the device, causing device malfunction.
  - Do not drive the device at speeds of 5 mph or higher, including when the brakes are released.  
There is a risk of device malfunction.
-  ● Do not pull strongly on the USB port cap.  
There is a risk of damage to the cap.

## ■ Precautions regarding the battery and charger

	<ul style="list-style-type: none"> <li>● <b>Carefully read and follow the instructions in this manual regarding the battery and charger.</b> If used incorrectly, there is a risk of injury or damage to the battery or charger.</li> </ul>
	<ul style="list-style-type: none"> <li>● <b>Device battery should not be charged while your body is in contact with the battery or charger.</b> There is a risk of low temperature burns.</li> </ul>
	<ul style="list-style-type: none"> <li>● <b>Never attempt to disassemble the battery or charger.</b> There is a risk of explosion.</li> </ul>
	<ul style="list-style-type: none"> <li>● <b>Never touch the device connectors.</b> There is a risk of serious injury or electric shock. Doing so will also invalidate the device warranty.</li> </ul>
	<ul style="list-style-type: none"> <li>● <b>Do not use an extension cord with the charger.</b> There is a risk of electric shock, short circuit, and fire.</li> <li>● <b>Do not pull the connector cord with excessive force.</b> There is a risk of electric shock, short circuit, and fire.</li> <li>● <b>Charge the device using a household power supply.</b> There is a risk of electric shock, short circuit, and fire. Charge using a 100 - 240 V, 50 - 60 Hz wall-mounted outlet.</li> <li>● <b>Do not charge with wet hands.</b> There is a risk of electric shock.</li> </ul>
	<ul style="list-style-type: none"> <li>● <b>Do not allow flame close to the battery or charger, allow these components to become wet, subject them to impact (dropping, poking with a nail, stepping on, etc.), or engage in similar acts.</b> There is a risk of fire or battery explosion.</li> </ul>

 **CAUTION**

	<ul style="list-style-type: none"><li>● <b>Do not use the charger provided with the device to charge any other battery.</b> There is a risk of damage to the charger.</li><li>● <b>Charge at an ambient temperature between 0 and 40 °C (32 and 104 °F).</b> Charging at a temperature outside this range may cause deterioration of or damage to the battery.</li><li>● <b>It is recommended to charge the device each time after using it.</b> If the battery has not been fully charged before the next use, insufficient charge level can occur.</li><li>● <b>If the device is not used for a long period, be sure to charge it at least once every 3 months.</b> If it is left uncharged, there is a risk that the battery may get excessively depleted.</li></ul>
	<ul style="list-style-type: none"><li>● <b>Do not charge the battery while the brakes are released.</b> There is a risk that the device may move, causing an unexpected accident.</li><li>● <b>Do not store the device for extended periods with the battery removed.</b> There is a risk of battery deterioration. If it is unavoidably necessary to store the without the battery , be sure to close the battery charging port cap.</li></ul>
	<ul style="list-style-type: none"><li>● <b>Use only the charger and AC connector cord that were provided with the device.</b> Using a charger or AC connector cord other than the one supplied may result in electric shock, or in burns caused by charger overheating. In addition, do not use the charger and AC connector cord that were provided with the device with any device other than this device.</li></ul>

## 1.1. Precautions for Use

The WHILL Model Ci is a personal electric vehicle. Be sure to correctly understand the contents of this manual before using the device. Persons who find it difficult to use a powered device should refrain from use of the device. Pay attention to the following precautions when using and handling the device.

- The device is designed for use on ordinary paved roads or indoors use.
- If this device is operated by a caregiver, that person must carefully read this manual and fully understand the precautions for use before using it.

## 1.2. EMI (Electromagnetic Interference)

There is a risk of unintended movement of this device as a result of radio waves. Radio waves are a form of electromagnetic (EM) energy and may adversely affect the operation of electronic devices. This phenomenon is known as electromagnetic interference (EMI) or radio frequency interference (RFI). Radio waves may interfere with the control functions of this device.

If the device moves or stops when the device controller is not operated, or if the device operates in a way different than intended, take the following actions.

- Write down the controller operation that was being performed at that time.
- Write down the device operation that could not be activated using the controller.
- Write down the mobile phones and other electronic devices that may be sources of radio waves and were present close to the device.

Based on these notes, consider the possible cause of radio frequency interference and remove it. If the problem is still not resolved, consult with your distributor or WHILL Customer Support. At this time, keep your earlier notes at hand.



If radio frequency interference is suspected, turn off the power and disconnect the battery.



### 1.2.1. General Q&A

The following are general questions and answers regarding steps to avoid the effects of EMI (electromagnetic interference) and RFI (radio frequency interference) with this device as much as possible. Please use them as reference.

● **Where do radio waves come from?**

Radio waves are emitted by unidirectional or bidirectional radio devices. Such devices include transceivers, mobile phones, wireless computer links, microwave generators, and radio call transmitters. Radio waves are a form of electromagnetic (EM) energy, and the strength of the energy increases at closer distances to the transmitting antenna. This electromagnetic field can cause problems for users of electric equipment.

● **What kind of movements should I expect if a personal electric vehicle is affected by EMI or RFI?**

EMI and RFI undergo extremely large dynamic changes and may affect a powered device depending on conditions such as the following.

- Radio wave frequency and strength
- Structure of the power supply equipment
- Inclination of the powered device (whether the ground is flat or a slope)
- Whether or not the powered device power is turned ON and whether or not it is moving

If this device is affected, there is the possibility of abnormal movement. It may begin moving or stop suddenly without being commanded to do so. If the source of EMI or RFI is strong, there is even the possibility of damage to the control system.

## 1.3. Location of Warning Labels

Warning labels are used on the device to point possible hazards. Labels also indicate the lock and unlock positions of levers and keys, position adjustment methods, and other reference information for operation. The following is an explanation of the label types and the locations where they are applied.

 **CAUTION**





- Do not remove the labels.





The labels contain important information.

### 1.3.1. Label types

#### ■ Warning labels









The following is an explanation of the warning labels used on this device.

Symbol	Label	Meaning
<b>A</b>		<p>Magnetic connectors are located at the device connection between the seat assembly and rear drive base, and the connection between the battery and rear drive base. The magnetic field of the magnetic connectors may have an adverse effect on electrical medical devices.</p> <p>Persons who have an implanted pacemaker, implanted defibrillator, or other electrical medical device on their bodies must stay a minimum of 8 inches (20 cm) away from the magnetic connectors.</p>
<b>B</b>		The surface may be hot. Do not touch.
<b>C</b>		<p>If the removed seat assembly is placed upside-down, there is a risk that the controller knob may be damaged, rendering the device inoperable.</p> <p>When placing the seat assembly on the floor, place it with the cushion facing up and be careful not to apply an excessive load to the controller knob.</p>

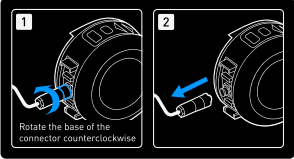
Symbol	Label	Meaning
D		<p>Inserting a finger or other body part into the connecting components and moving parts of this device may result in an injury.</p> <p>When assembling, adjusting, disassembling, and transporting this device, do not touch any component other than those indicated in the manual.</p>
E		<p>Indicates the base release lever lock position and unlock position. Check that the base release lever is locked before driving.</p>
F		<p>Indicates precautions</p> <ul style="list-style-type: none"> <li>• Be sure to read the User Manual before use.</li> <li>• Check that the brakes are locked before use.</li> <li>• Do not leave this device with the brakes released.</li> <li>• Do not use the device as a seat in an automobile or other vehicle</li> </ul>
G		<p>The maximum storage basket load is 13 lbs (6 kg). If a larger load is placed in it, the storage basket or accessory bar may be damaged.</p> <p>Do not place any item in the storage basket which weighs more than the maximum load.</p>

■ Other labels

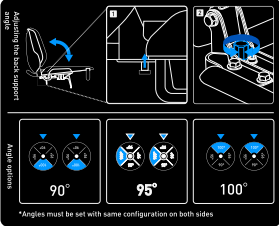
The following is an explanation other labels used on this device.

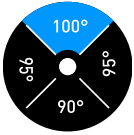
Symbol	Label	Meaning
H		Indicates the brake release levers lock position and unlock position.
I		Indicates the arm length adjustment position. The arm length can be adjusted in 4 stages.
J		Indicates the procedure for disconnecting the connectors from the directional controller assembly and control pad.
K		Indicates the battery removal key lock position and unlock position.
L		Indicates the device disassembly procedure.
M		Indicates the seat assembly insertion position when installing the seat assembly onto the rear drive base.
N		Indicates the procedure for adjusting the back support angle (90°, 95°, or 100°).
O		Indicates the reference point that is checked when the back support angle is adjusted.
P		Indicates the back support angle adjustment positions (90°, 95°, 100°).

### 1.3.2. Label application locations

The position where each label is applied is as shown in the figure below.

#### ■ Device

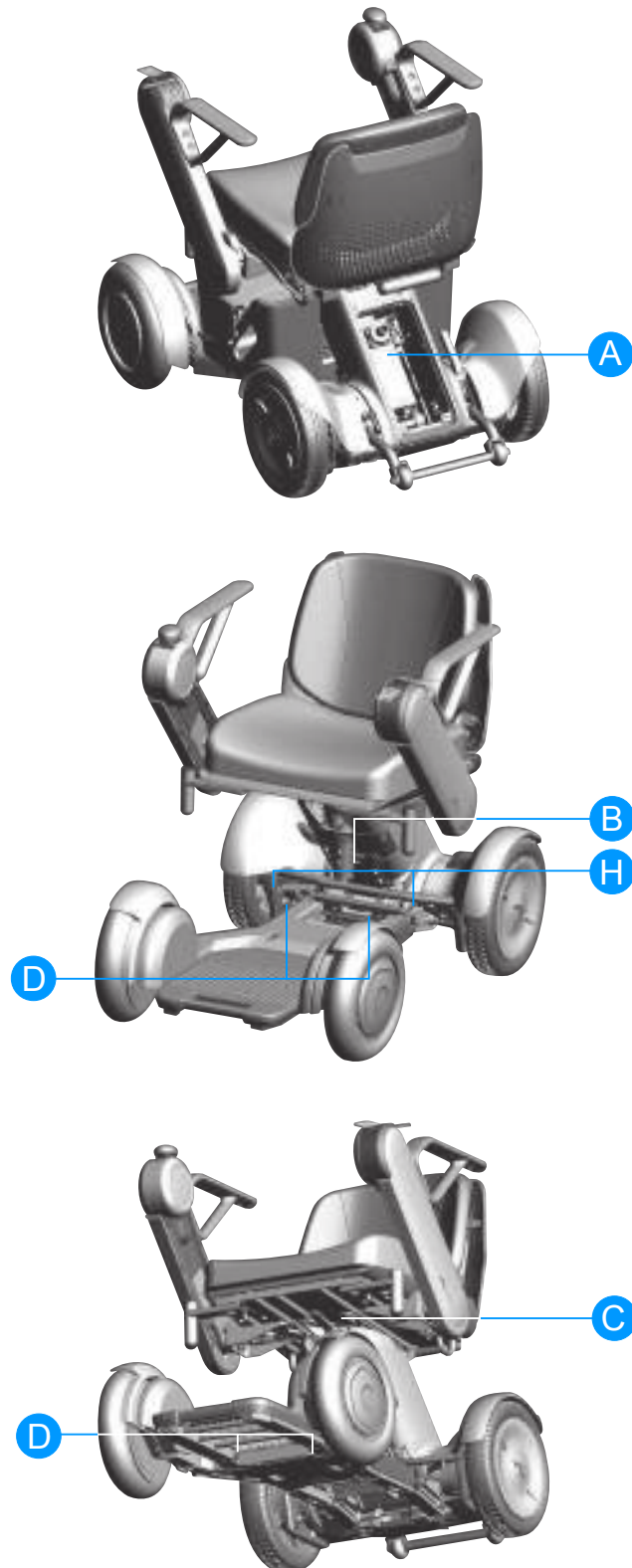

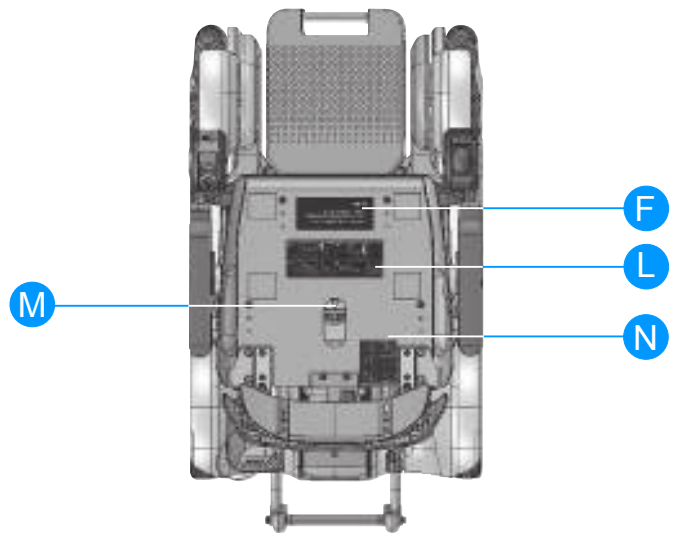
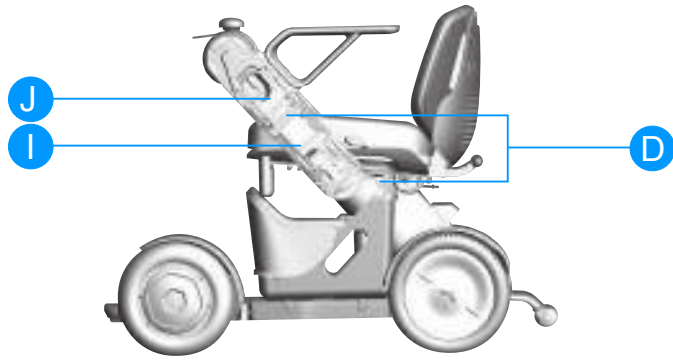

Seat assembly top view

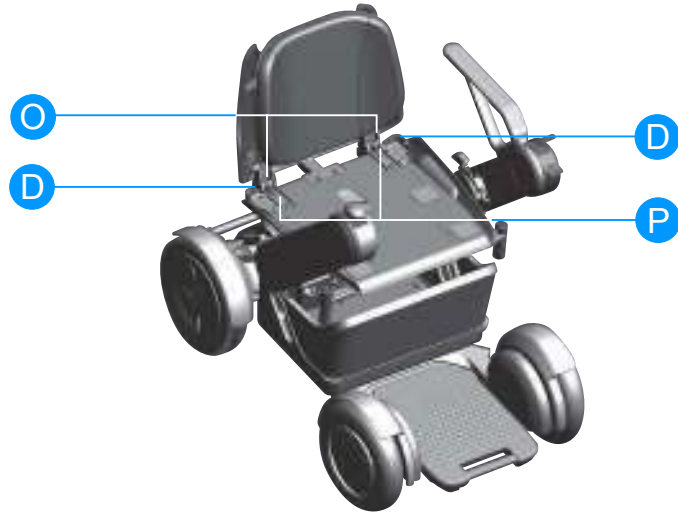

Parts with seat cushion removed

■ Storage basket

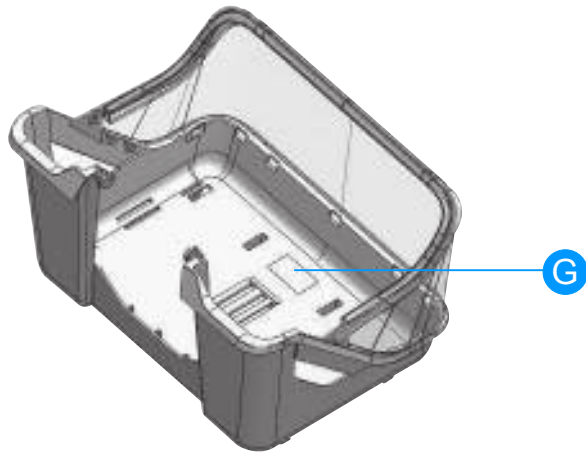

## 1.4. Location of Serial Number

The location of the serial number is shown in the figure below.

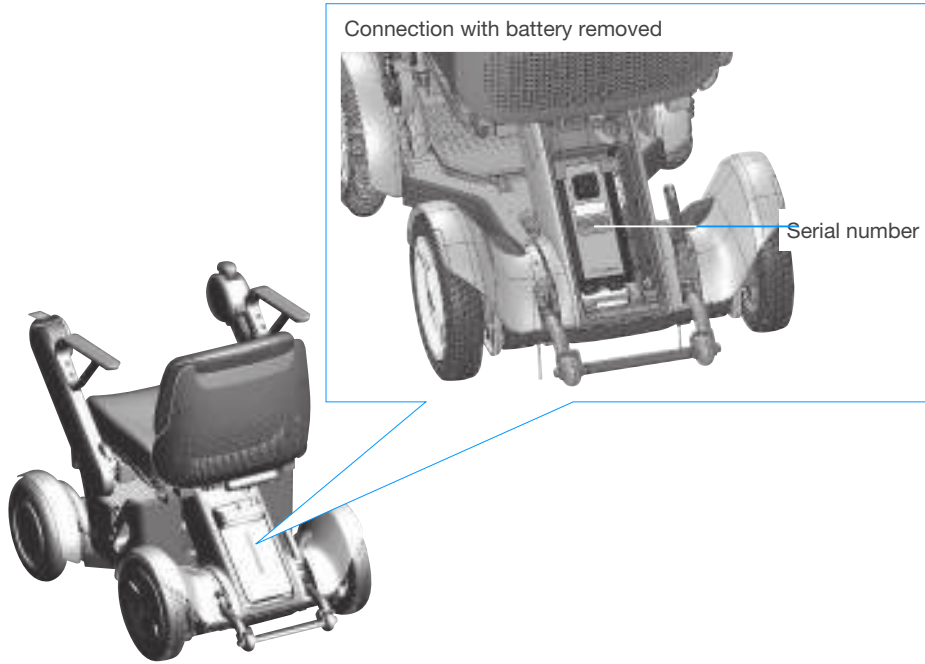



## 2. About This Device

### 2.1. Checking the Contents

This device contains the following components. After delivery be sure to check that there are no missing or damaged components. If any component is missing or if the device is damaged, contact the distributor or WHILL Customer Support.

- WHILL Model Ci (including battery and storage basket)
- Charger
- Smart key (if included)
- User Manual (this manual)
- Quick Start Guide



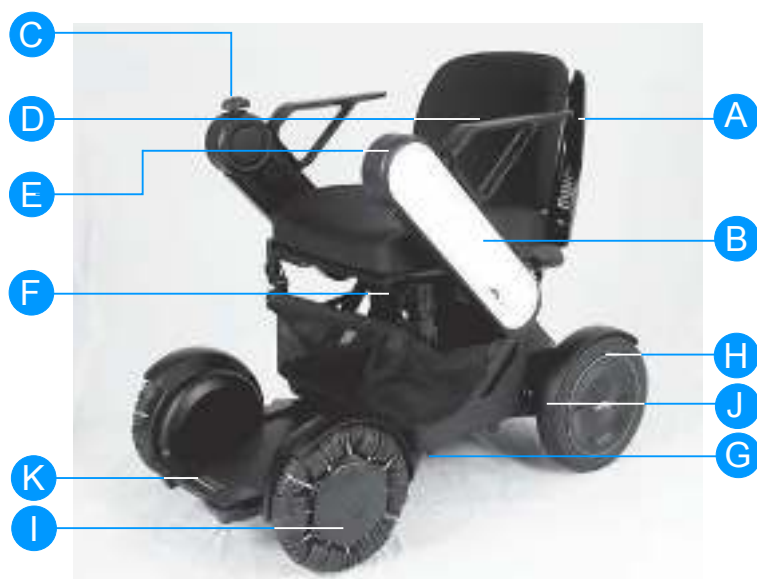

Be careful not to scratch the exterior when opening the package.

### 2.2. Names and Functions of Parts





#### ■ External view







\* The photos show a right-handed model.

<p><b>A</b></p>	<p>Back support</p>	<p>This is the device backrest.</p>	
<p><b>B</b></p>	<p>Arm</p>	<p>This is the diagonal part located on the left and right sides.</p> <p>The directional controller assembly (c) and control pad (e) are installed on the end.</p>	
<p><b>C</b></p>	<p>Directional controller assembly</p>	<p>This is the round unit where the directional controller assembly is installed.</p> <p>It controls the movement forward, backward, left, and right. The degree of controller knob inclination can also control acceleration and deceleration.</p>	
<p><b>D</b></p>	<p>Arm rest</p>	<p>This is the device arm rest.</p>	

Symbol	Name	Explanation	Photo
E	Control pad	<p>This is the round unit where the various buttons are located.</p> <p>It can be used to control the following functions.</p> <ol style="list-style-type: none"> <li>1. Speaker</li> <li>2. Display</li> <li>3. Speed increase button</li> <li>4. Speed decrease button (decelerate)</li> <li>5. Horn</li> <li>6. Power button</li> </ol>	
F	Seat assembly release lever	<p>This lever is used to separate the seat assembly from the rear drive base.</p>	
G	Storage basket	<p>This basket is used to carry storage items.</p> <p>It is installed onto the front drive base.</p>	
H	Rear wheel	<p>This is the device rear wheel.</p>	

Symbol	Name	Explanation	Photo
I	Front wheel (Omni-wheel)	This is the device front wheel.	
J	Brake release levers	This lever is located near each of the rear wheels below the seat. There are two such levers in total.	
K	Foot rest	This platform supports the user's feet when the user is sitting on the device.	
L	USB port	This is the port for connecting the USB cable.	
M	Rear tail light	This is a red vertical LED light located on the battery.	

Symbol	Name	Explanation	Photo
N	Battery	This is the lithium-ion battery supplied with the device.	
O	Base release lever	This lever is used to separate the rear drive base from the front drive base.	
P	Anti-tip bar	This bar prevents the device from tipping over to the rear.	
	Charger	This is used to charge the battery.	
	Smart key (if purchased)	This is used to lock the device.	

## 2.3. Accessories

Be sure to use only genuine accessories.

For the accessories that can be installed onto this device, contact your distributor or WHILL Customer Support.

Or, visit the WHILL Website (<http://whill.us>).

## 3. Charging the Battery





Be sure to charge the battery before using a WHILL Model Ci for the first time.

Also charge the battery before using if the device has not been used for a long period of time.

This device is designed for a maximum travel range of 10 miles under ideal conditions; however, the actual drivable distance varies depending on the driving conditions including hills, curves, steps, terrain, driving habits, load, and temperature. When if the Device is to be used for a long period of time, it is recommended that attention be given to the following.

- Fully charge the battery before use.
- Reduce the weight of the storage items as much as possible.
- Plan your route to avoid hills and obstacles.
- Maintain constant speed and avoid sudden stops and frequent stops.

### WARNING

	<ul style="list-style-type: none"> <li>● <b>Carefully read the explanations in this manual regarding the battery and charger and follow the instructions.</b> If used incorrectly, there is a risk of injury or damage to the battery or charger.</li> </ul>
	<ul style="list-style-type: none"> <li>● <b>Never attempt to disassemble the battery or charger.</b> There is a risk of explosion.</li> </ul>
	<ul style="list-style-type: none"> <li>● <b>Never touch the device connectors.</b> There is a risk of serious injury or electric shock. Doing so will also void the device warranty.</li> </ul>
	<ul style="list-style-type: none"> <li>● <b>Do not allow flame close to the battery or charger, allow these parts to become wet, subject them to impact (dropping, poking with a nail, stepping on, etc.).</b> There is a risk of fire or battery explosion.</li> </ul>

 **CAUTION**

- **Be sure to install the cap when the battery charging port or USB port is not in use.**  
There is a risk of short circuit caused by intruding foreign objects.
- **Do not pull strongly on the USB port cap.**  
There is a risk of damage to the cap.
- **Do not use the charger provided with the device to charge any other battery.**  
There is a risk of damage to the charger.
- **Routinely to charge the device each time after using it.**  
Fully charged battery can prevent an insufficient charge level from occurring.
- **Charge in a well-ventilated space that is free of flammable gases and that is at least twice the size of the device.**  
There is a risk of explosion or other accident if the space is filled with flammable gas or if ventilation is insufficient.



- **Do not leave the device for a long time with the battery removed.**  
There is a risk of battery deterioration. If it is unavoidably necessary to leave the device with the battery removed for a long time, be sure to close the battery charging port cap.



- The charger is for indoor use only. Do not charge the battery outdoors.
- If you have any questions about the battery, please contact your distributor or WHILL Customer Support.



### 3.1. Battery Components

#### ■ Battery

This device uses a lithium-ion battery with a voltage rating of 25.2 V.



#### ■ Charger



## 3.2. Charging Procedure

Be sure to charge the battery before using the device for the first time or when it has not been used for a long period of time.

There are 2 ways of charging the battery: charging with the battery installed in the base, and charging with the battery removed from the base.



- The device cannot be used while the battery is being charged.
- The approximate charging time is 5 hours.
- The charger is designed to prevent overcharging. Even if the charger is left plugged in for more than 5 hours, there is no risk of the device being damaged. However for safety, avoid leaving the charger plugged into the wall outlet for a long period of time.
- In an emergency, the device can be driven when charging has not been completed.

### WARNING



- **Do not** while your body is in contact with the battery or charger.  
There is a risk of low temperature burns.
- **Do not touch the battery connectors, allow them to become wet, or bring any metal or other foreign objects close to them. There is a risk of injury and of damage to the device or its parts.**



- **Do not use an extension cord with the charger.**  
There is a risk of electric shock, short circuit, and/or fire.
- **Do not pull with excessive force on the AC connector cord.**  
There is a risk of electric shock, short circuit, and/or fire.
- **Charge the device using a household power supply.**  
There is a risk of electric shock, short circuit, and fire. Charge using a 100 - 240 V, 50 - 60 Hz wall-mounted outlet.
- **Do not charge with wet hands.**  
There is a risk of electric shock.

 **CAUTION**

- **Do not charge the battery while the brakes are released.**  
There is a risk that the device may move, causing an unexpected accident.



- **Charge at an ambient temperature of 0 to - 45°C (32 to -49°F).**  
Charging at a temperature outside this range may cause deterioration of or damage to the battery.
- **If the device is not being used for a long period, be sure to charge it at least once every 3 months.**  
If it is left uncharged, there is a risk that the battery may get excessively depleted.



- **Use only the charger and AC connector cord that were provided with the device.**  
Using a charger or AC connector cord other than the designated parts may result in electric shock, or in burns caused by overheating of the charger.  
In addition, do not use the charger and AC connector cord that were provided with the device with any device other than this device.

### 3.2.1. Charging with the battery installed in the base

For safety, it is not possible to turn on the device power while the battery is being charged.

1. Move the device close to the outlet.
2. Turn off the device power.
3. Connect the charger and AC connector cord.
4. Plug the charger into the wall outlet.  
The power/charge indicator illuminates red.

Power/charge  
indicator



5. Remove the battery charging port cap, check the orientation of the DC connector, and connect the DC connector cord to the battery charging port.  
The power/charge indicator begins flashing green, and charging starts.



Cap

6. Charging is completed when the power/charge indicator stops flashing and turns solid green.
7. Disconnect the plug from the wall outlet and disconnect the DC connector cord from the battery.
8. Close the battery charging port cap.

### 3.2.2. Charging with the battery removed

1. Check that the device power is off.
2. Insert the key into the keyhole at the top of the battery and turn the key to unlock the battery.



Keyhole

3. Grasp the handle and pull it towards you to remove the battery.



The battery weighs 6.2 lbs (2.8 kg). Be careful not to drop it when removing it. There is a risk of injury and of damage to the battery.

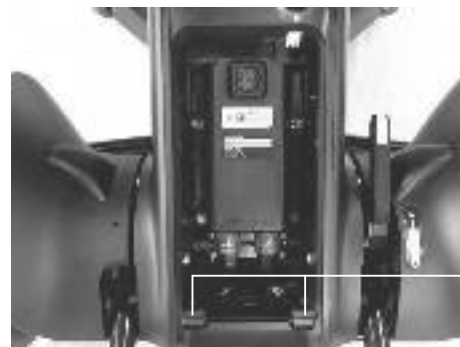

Projections

4. Connect the charger and AC connector cord.

5. Plug the charger into the wall outlet.

The power/charge indicator illuminates red.



When the power/charge indicator is illuminated red, the connector is not properly connected. In this case, disconnect and reconnect again.

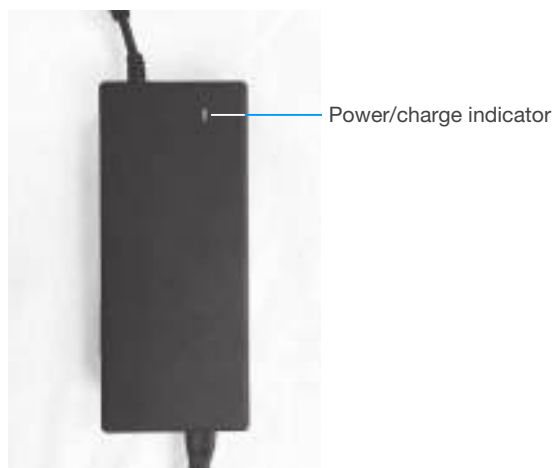

6. Remove the battery charging port cap, check the orientation of the DC connector cord, and connect the DC connector cord to the battery charging port.

When charging starts, the following lamps begin flashing.

- Battery: Charge level indicator begins flashing.
- Charger: Power/charge indicator begins flashing green.



If the power/charge indicator is not flashing green, the connector is not properly connected. In this case, disconnect and reconnect again.



7. Charging is completed when the charge level indicator turns off and the power/charge indicator stops flashing and turns solid green.

8. Disconnect the plug from the wall outlet and disconnect the DC connector cord from the battery.



9. Close the battery charging port cap.

10. Install the battery onto the device.

- 1) Grasp the battery handle and align the battery with the projections on the bottom of the mounting area.



The battery weighs 6.2 lbs (2.8 kg). Be careful not to drop it when handling it. There is a risk of injury, and of damage to the battery.

- 2) Press the top of the battery in to install it.

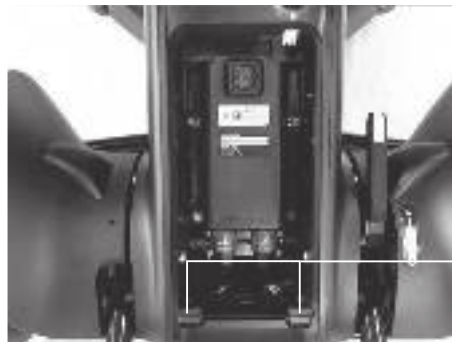

11. Turn the key counter-clockwise to lock the battery, and then remove the key.



### 3.2.3. Power/charge indicator indications

The charger power/charge indicator illuminates or flashes according to the battery state as shown below.

- Flashing green: Charging
- Solid green: Charging completed
- Solid red: Standby
- Flashing red: Charging error\*

\* Charging is not possible when the power/charge indicator is flashing red.

Disconnect the plug from the wall outlet. Then after the power/charge indicator turns off, connect the plug again.

If the problem is still not solved, contact your distributor or WHILL Customer Support.

## 3.3. Checking the Charge Level of the Removed Battery

The battery charge level can be checked even when the battery is removed from the device.

**Press the charge level button.**

The battery charge level is indicated by the scale on the charge level indicator.

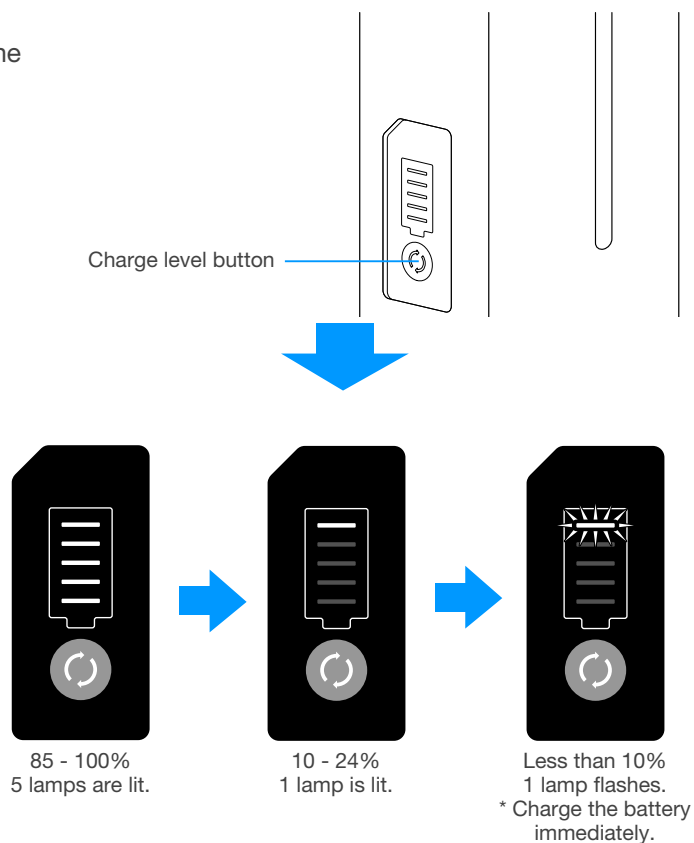



### 3.3.1. Charge level indicator error indication

When there is a problem with the battery, it is indicated on the charge level indicator as shown below.

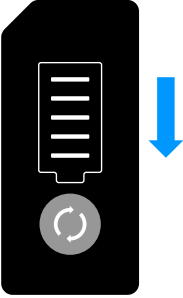
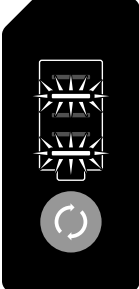
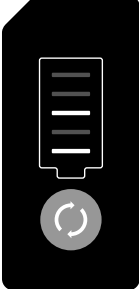
 <p>Lamps illuminate repeatedly in sequence from top to bottom.</p>	<p>Battery overcurrent</p>	<p>Disconnect the battery from the device or charger and then reconnect it.</p>
 <p>The 2nd and 5th lamps from the top are flashing.</p>	<p>Battery temperature error (outside of the range)</p>	<p>Keep the battery at room temperature for a while and then use it again. If the error still occurs, contact your distributor or WHILL Customer Support.</p>
 <p>The 3rd and 5th lamps from the top are illuminated.</p>	<p>Charging temperature error (outside of the range) * Only when the charger is connected</p>	<p>Keep the battery at room temperature for a while and then use it again. If the error still occurs, contact your distributor or WHILL Customer Support.</p>

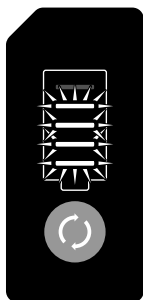
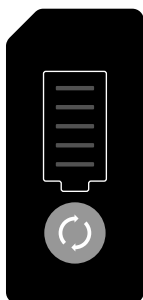
Indication	Problem	Correction
 <p data-bbox="161 551 523 618">All lamps except the top lamp are flashing.</p>	Battery malfunction	Contact your distributor or WHILL Customer Support.
 <p data-bbox="185 943 499 972">All indicator lamps are off.</p>	Insufficient charge level	Charge the battery. If the indicator does not appear even after charging, contact your distributor or WHILL Customer Support.



### 3.4. Battery Inspection and Replacement

If the usable time after charging has become abnormally short and the battery must be replaced, contact your distributor or WHILL Customer Support.



## 4. Operating Procedures

This section explains the procedures for getting in and operating the Device.

### WARNING

	<ul style="list-style-type: none"> <li>● <b>Do not sit on the controller knob, place the removed seat assembly upside down, or apply an excessive load to the controller knob.</b> There is a risk that the controller knob may be damaged, rendering the device inoperable.</li> <li>● <b>Do not press the buttons with strong force or using a sharp object.</b> There is a risk that the control pad may be damaged, rendering the device inoperable.</li> <li>● <b>Do not apply the weight of your body to the control pad, controller knob, or the accessory bar.</b> There is a risk that these parts may become disconnected, rendering the device inoperable.</li> </ul>
	<ul style="list-style-type: none"> <li>● <b>When using the device for the first time, be sure to check the device for damage before using it.</b> If the device is damaged, there is a risk of an unexpected accident.</li> </ul>

### CAUTION

	<ul style="list-style-type: none"> <li>● <b>Do not place a load on the directional controller assembly or scratch it with a sharp object.</b> There is a risk that the directional controller assembly may be damaged, rendering the device inoperable.</li> <li>● <b>Do not throw, step on, or otherwise subject the removed control pad or directional controller assembly to strong impact, and do not immerse these parts in water.</b> There is a risk that the switch or directional controller assembly may be damaged, rendering the device inoperable.</li> </ul>
	<ul style="list-style-type: none"> <li>● <b>If the device is not used for a long period, be sure to charge it at least once every 3 months.</b> If it is left uncharged, there is a risk that the battery may become excessively depleted.</li> </ul>

## 4.1. Inspection Before Getting into the Device

Perform the following inspection before getting into the device.

### ■ Inspection contents

#### 1. Inspection with the power off

- Check that the power is turned off.
- Check that all parts are correctly assembled and that there are no missing or broken parts.
- Check that there is no damage, corrosion, or other problems.
- Check that the device exterior, arm, anti-tip bar, and other parts are not deformed, damaged, or loose.
- Check that the connecting parts at release points are not deformed, damaged, or loose.
- Check that the controller knob moves smoothly.
- Check that there is no cracking or wear of the front omni-wheels.
- Check that there is no cracking or wear of the rear wheels.
- Check that the prural brakes can be released and the device can be pushed manually.
- Check that when the prural brakes are locked, the wheel chair does not move when pushed.
- Check that the anti-tip bar is lowered.
- Check that the release levers are locked.

#### 2. Inspection with the power on

- Check the battery charge level indicator and check that the charge level is sufficient.
- Check that the switches on the control pad function.
- Check that the display function correctly.
- Check that the horn is functional.



If any problems which you cannot correct yourself are found during the above inspection, contact your distributor or WHILL Customer Support.

## ⚠ WARNING



- **Be sure to check the following before getting into the device.**

There is a risk of unexpected accident.

- Check that the brakes are not released.
- Check that the anti-tip bar is lowered.



Lowered



Raised



- **Check that the release levers are locked before getting into the device.**

If the release levers are not locked, there is a risk of the device malfunction during use. If it is not possible to lock the release levers, immediately discontinue use and contact your distributor.

- **Before use, check that all components are properly assembled and that there are no missing or broken parts.**

If there is a component which is missing or broken, it may cause an accident or malfunction during use.

## ⚠ CAUTION



- **Check that the arm is locked before beginning operation.**

There is a risk that the arm may move during driving, causing an unexpected accident.



- **If any device component is lost, immediately discontinue use and contact your distributor.**

There is a risk of damage to the device that renders it inoperable.



## 4.2. Getting into the Device

Pay attention to the following when boarding.

### WARNING

	<ul style="list-style-type: none"> <li>● <b>Do not apply the weight of your body to the control pad, controller knob, or accessory bar.</b> There is a risk that these parts may become disconnected, rendering the device inoperable.</li> <li>● <b>Do not jump onto the foot rest, step onto the foot rest while carrying a heavy object, or otherwise place an excessive load on the foot rest.</b> There is a risk of the device being lifting up and/or tipping over.</li> </ul>
	<ul style="list-style-type: none"> <li>● <b>Turn off the device power when getting into and out of the device.</b> There is a risk of unexpected movement of the device caused by accidental contact with the controller knob.</li> <li>● <b>Lock the brakes before getting into the device.</b> If the brakes are released, there is a risk that the device may start moving and tip over.</li> <li>● <b>If your body is not stable in the seat assembly, be sure to use the lap belt (if purchased).</b> There is a risk of falling out of the device. If the device you are using does not have a lap belt, contact your distributor.</li> </ul>

### CAUTION

	<ul style="list-style-type: none"> <li>● <b>Do not apply force to the device from the side directions.</b> There is a risk that the device may slip. Do not forcefully push or pull the device from the side.</li> </ul>
	<ul style="list-style-type: none"> <li>● <b>When using your own cushion, for safety, be sure to use a cushion that has passed a fire-resistance test.</b></li> </ul>

### 4.2.1. Accessing the seat from the front

1. Raise the foot rest.



2. Sit in the seat assembly.



- Be careful that your hands do not contact the control pad or the controller knob.
- Since the back support can be folded forward, do not pull it toward you or apply force to it in the forward direction. There is a risk that the back support may tilt forward, causing an unexpected accident.



3. Lower the foot rest.



### 4.2.2. Accessing the seat from the side

It is recommended that you get in the device as shown below.

#### 1. Raise the arm.

- 1) Raise the arm release lever.
- 2) Rotate the arm backwards.



#### 2. Sit in the seat assembly.



- Be careful that your hands do not contact the control pad or the controller knob.
- Because the back support can be folded forward, do not pull it toward you or apply force to it in the forward direction. There is a risk that the back support may tilt forward, causing an unexpected accident.



#### 3. Rotate the arm forward.



Check that the arm is locked.





### 4.3. Fastening the Lap Belt (If purchased)

If the device you are using is equipped with a lap belt, fasten it during usage.

To fasten the lap belt, connect the two buckles until a click sound is heard.





After fastening the belt and adjust its length so that your body is held securely in place.



## 4.4. Turning On the Power

### ⚠ WARNING

- |   |   |
|---|---|
|  | <ul style="list-style-type: none"> <li>● Do not press the control pad buttons with strong force or using a sharp object. There is a risk that the control pad may become damaged, rendering the device inoperable.</li> </ul> |
|  | <ul style="list-style-type: none"> <li>● Lock the brakes before turning on the power. If the brakes are released, there is a risk that the device may start moving and tip over.</li> </ul>                                   |

### ⚠ CAUTION

- |   |  |
|---|--|
|  | <ul style="list-style-type: none"> <li>● If the power does not turn on, check the magnetic connectors. The magnetic connectors are located at the connection between the seat assembly and rear drive base, and the connection between the battery and rear drive base.</li> </ul> |
|---|--|

Press the power button.

The power turns on.



When the power turns on, first the WHILL logo appears on the display, and next the current speed setting is displayed. After some time, the display changes to the battery charge level indicator.

To check the speed setting again, either turn the power off and back on, or else press the speed select buttons and adjust the speed.



#### 4.4.1. Checking the battery charge level

The battery charge level is shown on the display as a number in the range of 0 - 100, changing in increments of 1. When fully charged, the charge level is shown as "100".



#### 4.4.2. Adjusting the maximum speed

The device speed can be controlled by the degree of movement of the controller knob. The setting for the speed when the controller knob is tilted all the way (maximum speed) can be changed in 4 stages from 1 (slow) to 4 (fast) by operating the speed select buttons.

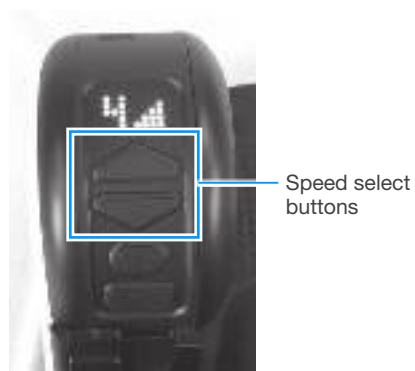

#### 4.4.3. Using the horn

To provide notice to the people in the surrounding area, press the horn button.



## 4.5. Driving

Move the controller knob forward, backward, left, and right to move the device in that direction. The speed can be adjusted by the degree of controller knob movement.

Releasing the controller knob automatically applies the brakes and stops the device.

When driving on a road, be sure to observe all traffic laws and practice safe driving at all times.





If you want to practice driving, do so in an open space with good visibility.



- **When operating the device while wearing gloves, be careful that the gloves do not become caught.**  
There is a risk that gloves may become caught in control parts, resulting in incorrect control.
- **Pay attention to the following while driving.**  
There is a risk of unexpected accident.
  - Fully check the surroundings and road conditions before driving.
  - Do not drive the device onto escalators or stairs.
  - Do not attempt to ascend or descend steps that are more than 2 inches (50 mm) high.
  - When driving at night or in places with poor visibility, check that the rear tail light is visible to other persons before using.
- **Be sure to drive carefully at low speed in cases when particular caution is necessary, such as in crowds of people, close to walls, or other locations where there are obstacles nearby, and in narrow places.**  
There is a risk of collision and tipping over.
- **When approaching curbs, steps, slopes, and similar obstacles, approach at a 90° angle and drive over them carefully at low speed.**  
There is a risk of tipping over or causing deformation of the base.
- **Drive carefully at low speed when driving on roads that are not flat or on slopes.**  
There is a risk of tipping over. As necessary, request help from people around you in order to stabilize the device.

 **WARNING**

- **When driving, make sure that the wheels do not contact your body or those of the people around you.**  
There is a risk of injury.
  - **When stopping on a downhill slope, release the controller knob early and make sure that you stop with a sufficient margin of extra space.**  
The brakes stopping distance is longer when on a downhill slope. There is a risk that you may be unable to stop within the intended distance, causing an unexpected accident.
-  ● **Never release the brakes when on a slope. Be sure to release the brakes only when on a flat surface.**  
There is a risk that the device may start moving, causing an unexpected accident.

- 
- **While riding the device, do not crouch down or lean your body outside the device. Be careful of moving the center of gravity while driving.**  
There is a risk of affecting the device stability and balance. If you are unsure about the device stability, request help from people around you in order to stabilize the device body.
  - **Avoid operating the device when wearing clothing or other items that can easily be caught in the rotating part of the arm, wheels, or other moving part.**  
There is a risk that clothing may be caught in these parts, preventing you from controlling the device.
  - **Do not take your feet off of the foot rest while driving.**  
There is a risk that your feet may be caught in moving parts. Keep your feet on the foot rest while driving.
  - **Do not drive with the foot rest raised.**  
There is a risk that your feet may be caught in moving parts.
  - **Do not drive while holding something in your hand or with something placed on your lap.**  
There is a risk of incorrect operation and tipping over.
  - **Do not drive on a soft road surface, such as sand or mud.**  
There is a risk of the device getting stuck.
  - **Do not drive through puddles or other water.**  
There is a risk of corrosion and short circuit.
  - **Do not extend arms, legs, or baggage outside of the device.**  
There is a risk of injury caused by collision while driving.
  - **Do not tow cargo.**  
There is a risk of tipping over.

 **CAUTION**



- **Pay attention to the following while driving.**

There is a risk of unexpected accident.

- Check that the arm is locked before beginning operation.
- Reduce speed when driving on a slope.

- **On roads, drive on the sidewalk.**

This device is not designed for use on automobile roadways, snow-covered roads, or frozen roads. When crossing roads, check that the drivers can see you and exercise sufficient caution while crossing.

- **When driving on uneven roads, drive carefully at low speed.**

There is a risk of accidentally causing unexpected operation.



If the battery temperature drops significantly during driving, battery low-temperature mode may be engaged, restricting operating speed and lowering the speed of the device. When attempting to drive up hill in low-temperature mode, the device may stop.

Low-temperature mode is canceled after the battery temperature is 0°C or higher.

### 4.5.1. Moving forward and backward

Move the controller knob forward to move the device forward, and backward to move the device backward.



### 4.5.2. Moving in a diagonal direction

To move in a diagonal direction, first turn the device so that it faces the direction you want to go. Then move the controller knob straight forward or backward to move forward or backward in the diagonal direction.

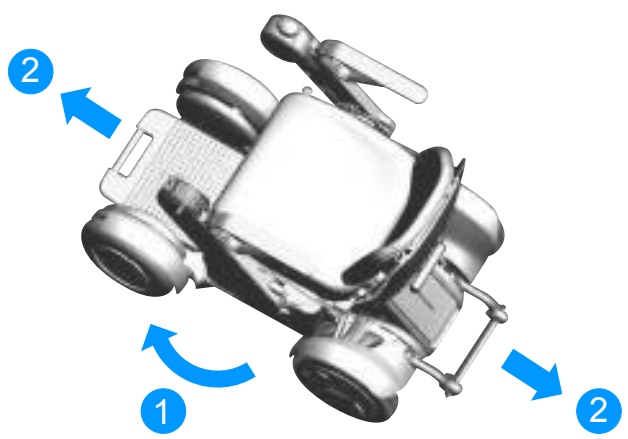
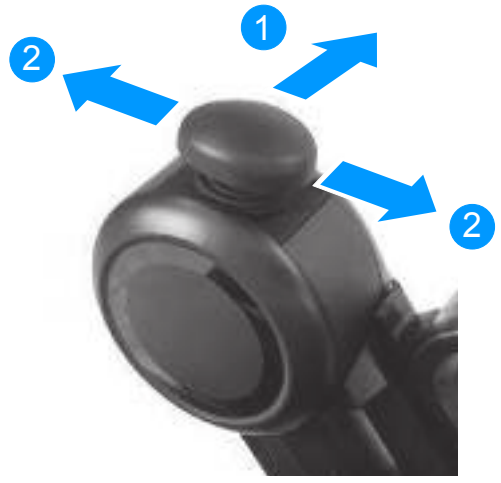



### 4.5.3. Turning

To turn in place, move and hold the controller knob to the left or right.

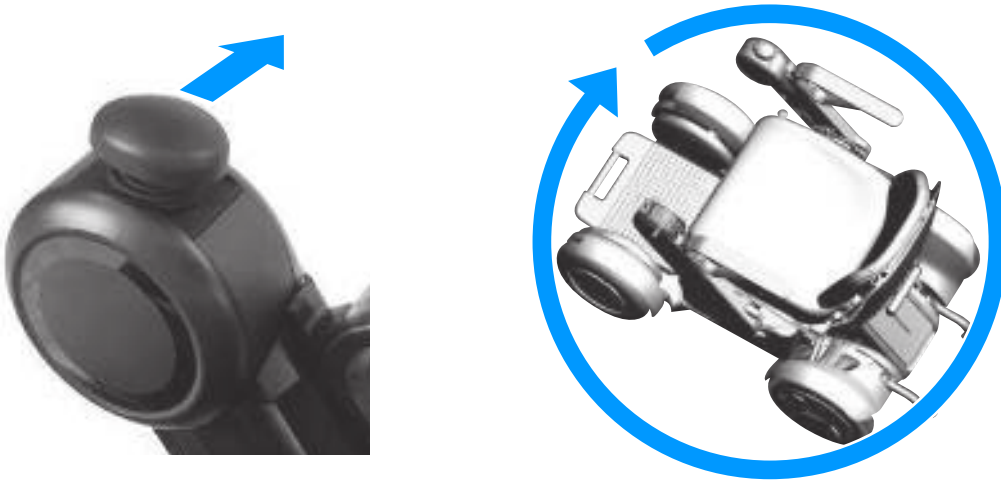

### 4.5.4. Stopping

Releasing the controller knob automatically applies the brakes and stops the device.

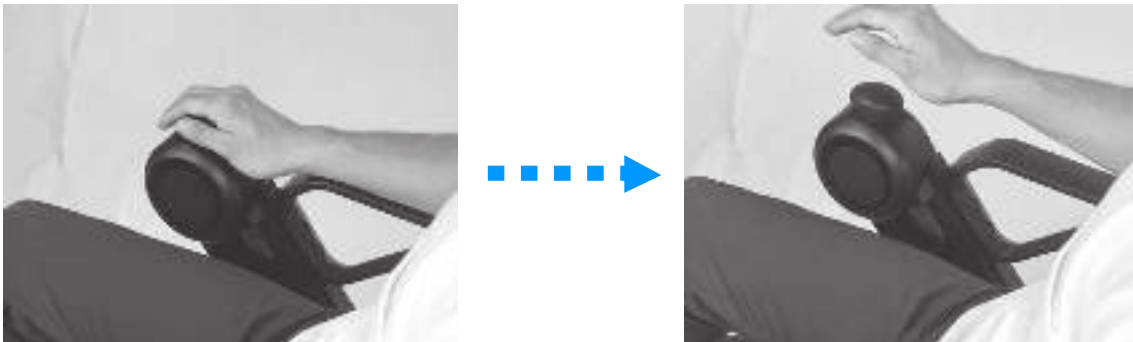

### 4.5.5. Controlling the speed

The device speed can be controlled by the degree of movement of the controller knob.

Increasing the angle of the controller knob increases the device speed while reducing the angle decreases the speed.

The speed can be controlled in a continuous scale.



High speed (large angle)



Low speed (small angle)



- When beginning driving, move the controller knob only by the necessary amount and start moving slowly.
- The maximum speed when the controller knob is moved all the way varies depending on the speed that was set with the speed select buttons. For the procedure used to set the maximum speed, refer to “4.4.2 Adjusting the maximum speed”.

#### 4.5.6. Driving under different road conditions

The Device provides driving stability under a wide range of conditions.

However, it cannot be driven under the following road conditions.

- Steps higher than 2 inches (50 mm)



- Slopes with gradients of 10° or more

10° or more  
(17%)



- Soft road surfaces such as sand and mud, and snowy roads and frozen roads  
\* Driving on gravel, light snow, and grass is possible.



## 4.6. Releasing the Brakes

To put the device into freewheel mode, release the brake levers located below the seat assembly.

### WARNING



- **Be sure to turn off the power before releasing the brakes.**  
There is a risk that the device may start moving, causing an unexpected accident.
- **Release the brakes only in emergencies. Do not leave the brakes released for an extended period of time.**  
When the brakes are released, the device will move freely. This is extremely dangerous.
- **After moving the device manually with the brakes released, be sure to raise the brake release levers and lock the brakes.**  
There is a risk of unexpected accident.



- **Never release the brakes when on a slope. Be sure to release the brakes only when in a flat location.**  
There is a risk that the device may start moving, causing an unexpected accident.
- **Do not drive the device at speeds of 5 mph or higher, including when the brakes are released.**  
There is a risk of device malfunction.

### CAUTION



- **When moving the device after releasing the brakes, push it by hand and move it slowly.**  
When the brakes are released, the device will move freely. Pushing it forcefully may cause it to move in an unexpected direction.

### 4.6.1. Release procedure

1. Turn off the device power.
2. Lower both brake release levers below the seat assembly to put the device into freewheel mode. To re-engage the brakes and put the device back to drive mode, raise both brake release levers.



## 4.7. Storage Basket

Place any storage items in the storage basket that is located under the seat assembly. Hang the two storage basket hooks onto the two accessory bars so that the stored items stay secure in the basket while driving.

### WARNING



- **Be sure to use the storage basket when carrying any items. Be sure that the stored items does not exceed the storage basket reference level height.**  
There is a risk of tipping over.

### CAUTION



- **Pay attention to the following when using the storage basket.**  
There is a risk of unexpected accident.
  - Turn the power off before putting any objects into or taking it out of the basket.
  - When removing any objects, check that the hook has been disconnected from the accessory bar. Connect and disconnect the hook by hand.
- **Before driving, check that the storage basket hook is connected to the accessory bar.**  
There is a risk of stored items falling out during driving.



- **Do not use paint thinner, benzene, or other organic solvents for cleaning, and do not use a high-pressure washer.**  
Doing so may result in discoloration, deformation, deterioration, and damage.
- **Do not place any items on the arm or arm rest.**  
There is a risk that the arm rest may become deformed or damaged.
- **Do not place any heavy objects on the back support.**  
The back support maximum load is 11 lbs (5 kg). If a larger load is applied to it, the back support may become damaged.

## ■ Storage basket



- The maximum storage basket load is 13.2 lbs (6 kg). If a larger load is placed in it, the storage basket or accessory bar may be damaged.
- The accessory bar maximum load is 11 lbs (5 kg).



## ■ Back support

When adjusting a backpack to the back support, hang the shoulder straps onto the hooks on the back support.



- The back support maximum load is 11 lbs (5 kg).
- Be careful that the shoulder strap or other part is not dragging on the ground.
- When driving at night, attach the backpack so that the rear tail light is visible.

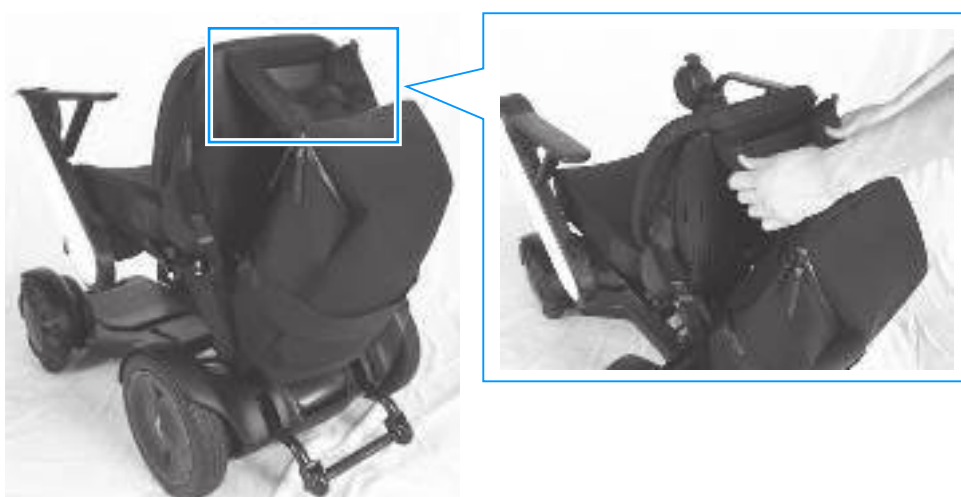

## 4.8. Locking the Device

The smart key (if purchased) can be used to lock the device.



- When the device needs to be locked at the point of destination or storage, be sure to carry the smart key with you. Although it is possible to lock the device using a smartphone, if the smartphone battery runs out, it will not be possible to lock or unlock the device.
- For the instructions to change the smart key battery, refer to “8.2 Replacing the smart key battery”.

### 4.8.1. Locking

**Press the smart key lock button.**

The smart key LED illuminates, and the icon indicating the locked status appears on the display. The device is now locked. When it locks, the rear tail light on the device flashes once.



If you attempt to turn the power on when the device is locked, the icon indicating the locked status appears on the display, and then the power turns off. The device cannot be started.

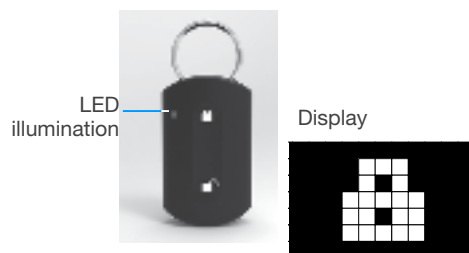
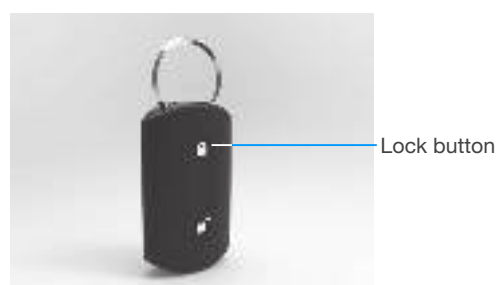

### 4.8.2. Unlocking

**Press the smart key unlock button.**

The smart key LED illuminates, and the icon indicating unlock appears on the display. The rear tail light flashes twice, and then the power turns off.

After checking that the device is unlocked, the power can be turned on, and the device can be used.

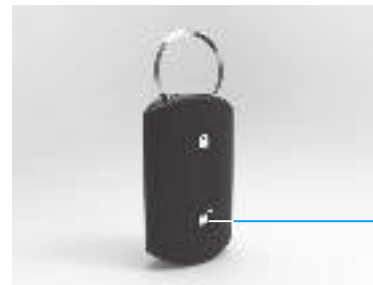

Unlock button



LED illumination

Display

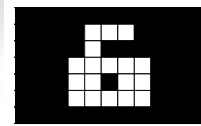

Rear tail light flashes once



## 4.9. Using the USB port

There is a USB port underneath the seat assembly above the battery.

It can be used to charge a smartphone or any other device.

### ⚠ CAUTION



- **When connecting the USB cable, check that there are no foreign substances in the connector.**  
Charging is not possible when there is a foreign substance caught in the connector.
- **Be sure to install the protective cap when the USB port is not in use.**  
If corrosion of the USB terminal occurs due to the intrusion of water or other substance, charging will not be possible.



- **Do not pull strongly on the USB port cap.**  
There is a risk of damage to the cap.



- This USB port is only for USB compatible devices such as smartphones.
- The USB port is rated for 5V, 500mA and does not support rapid charging.
- The USB port is only functional while the device power is on.
- If there is a problem with the USB cable, correct charging may not be possible.

1. Remove the USB port protective cap.

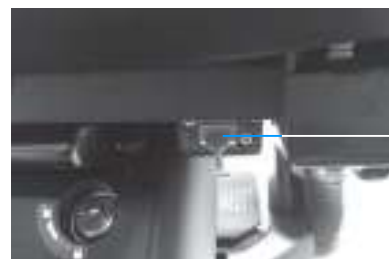

Protective cap



2. Press the power button and turn on the device.

3. Connect the USB cable to the USB port.

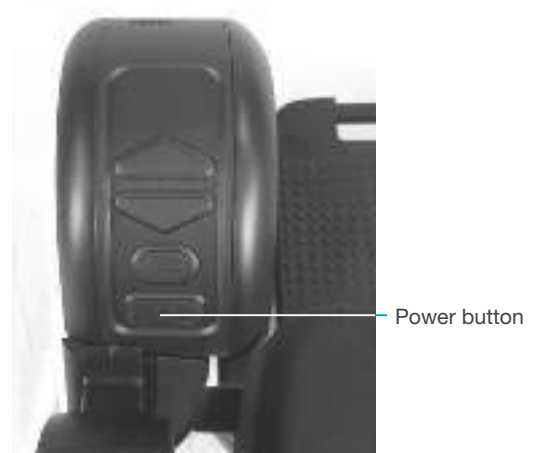

4. When finished, disconnect the USB cable and insert the protective cap back into the USB port.

## 5. Assembly, Adjustment, and Disassembly

This section explains how to assemble and disassemble the device, and how to adjust each component.

### ⚠ WARNING



- **Be sure to disassemble the device before lifting it up.**  
The weight of the device is approximately 115 lbs (52 kg). If it is lifted up without disassembly, there is a risk of bodily injury, and/or device damage.
- **Be careful of the weight when lifting up each component.**  
There is a risk of bodily injury, and/or device damage.



- **Do not perform any disassembly, adjustment, or repair that are not explained in this manual.**  
If the customer performs such acts him/herself, there is the serious safety risk. Consult with your distributor when adjusting the seat length or arm position. Only a trained service technician can provide maintenance on the device.
- **Do not disassemble, adjust, or repair the device, or lift the device up when there is a person on the device.**  
There is a risk of damage to the device, causing an unexpected accident.

### 5.1. Component List

This device can be disassembled into the following 5 components.

- Seat Assembly



- Front drive base



- Rear drive base



- Battery



- Storage basket



## 5.2. Assembly Procedures

Assembly of the device does not require tools. When assembling the device, pay careful attention to the following.

### WARNING



- **When assembling the front drive base and rear drive base, be sure to grasp the handle A.**  
There is a risk of injury if fingers are caught in the disassembly mechanism.
- **Perform assembly in a flat, level location.**  
There is a risk of unexpected accident.

### CAUTION



- **When assembling the device, grasp only the handle parts that are explained in this manual, and do not hold the device by any other areas.**  
There is a risk of injury caused when a hand become caught in the device.
- **When assembling, check that the magnetic connectors are not dirty.**  
If a magnetic connector is dirty, current may not flow through it, and the power may not turn on. The magnetic connectors are located at the connection between the seat assembly and rear drive base, and the connection between the battery and rear drive base.

### 5.2.1. Assembling the Front drive base and Rear drive base

1. Grasp the handle A and align handle B with the hook on the rear drive base.



2. Slowly tilt the rear drive base forward and connect the front drive base and rear drive base.
  - When the two components are correctly connected, a click sound is heard when the two components are currently connected.
3. Check that the anti-tip bar is lowered.



### 5.2.2. Installing the storage basket

1. Align the storage basket with the rear drive base.



2. Rotate the storage basket and place the basket onto the front drive base.



3. Fasten the velcro on the bottom of the storage basket to the front drive base.



Velcro fastener

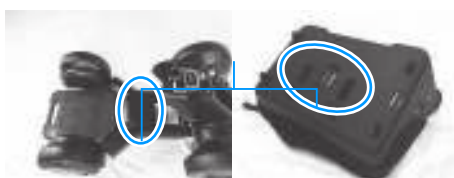

Front drive base

Bottom of storage basket

### 5.2.3. Installing the seat assembly

**⚠ WARNING**



- **Persons who have an implanted pacemaker, implanted defibrillator, or other electrical medical device on their bodies must stay a minimum of 8 inches (20 cm) away from the magnetic connectors.**

The magnetic connectors are located at the connection between the seat assembly and rear drive base, and the connection between the battery and rear drive base. The magneticism of the magnetic connectors may have an adverse effect on electrical medical devices.



- **Do not touch the battery connectors, allow them to become wet, or bring any metal or other foreign objects close to them.**

There is a risk of injury and of damage to the device or its parts.

**⚠ CAUTION**



- **Do not press a sharp object against or apply a load to the seatback cables located on the bottom of the seat assembly.**

There is a risk of breaking the cables.



Seatback cables



1. Remove the seat cushion from the seat assembly.



2. Grasp the arm rest and lift up the seat assembly.

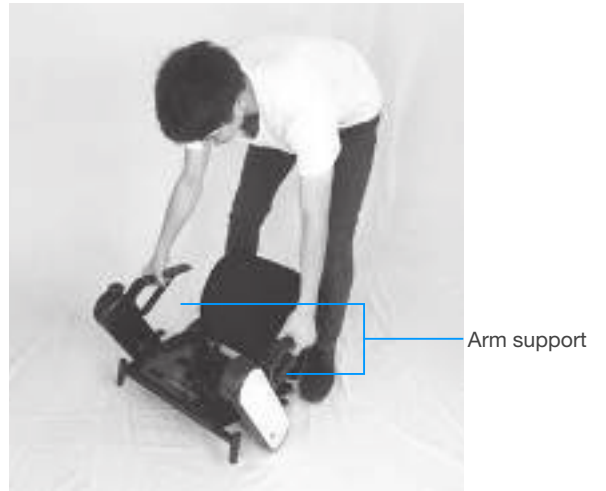

3. Fit the seat assembly straight into position while checking the seat post position from the view hole in the seat assembly.



Photo viewing from above

4. Install the seat cushion onto the seat assembly.

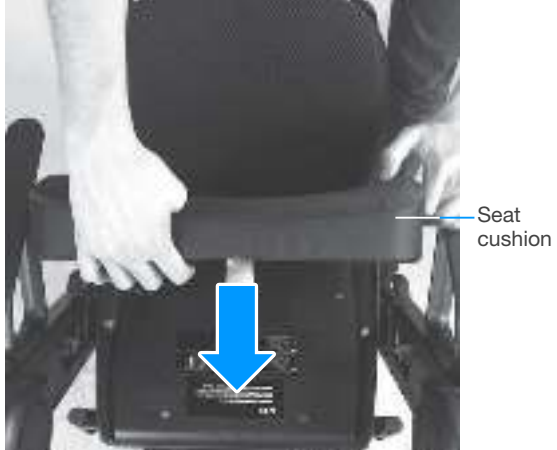

5. Lower the seat release lever.  
The seat is fastened onto the seat post.



6. Hang the storage basket hook onto the accessory bar.



## 5.2.4. Installing the battery

### WARNING



- Do not touch the connectors or battery connectors, allow them to become wet , or bring any metal or other foreign objects close to them.  
There is a risk of injury and of damage to the device.

1. Grasp the battery handle and align the battery with the s on the bottom of the mounting area.



The battery weighs 6.2 lbs (2.8 kg). Be careful not to drop it when handling it. There is a risk of injury or damage caused by the battery dropping.

2. Press the top of the battery in to install it.  
If the battery cannot not be installed even when pressing on it with some force, check whether the battery lock is engaged.

3. Turn the key counter-clockwise to lock the battery, and then remove the key.

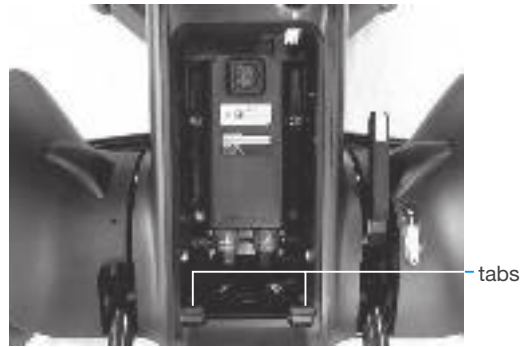

## 5.3. Adjustment Procedures

The following device adjustments can be made to meet the user's seating needs the body of the user.

- Arm length → “5.3.1 Adjusting the arm length” page 83
- Switching the left and right sides of the directional controller assembly and control pad
- → “5.3.2 Switching the left and right sides of the control assemblies” page 84
- Seat height → “5.3.3 Adjusting the seat height” page 89
- Back support height → “5.3.4 Adjusting the back support height” page 92
- Back support angle → “5.3.5 Adjusting the back support angle” page 93

### WARNING



- **When moving the arm up or down in order to adjust the arm length or for other reason, be careful that your fingers do not become caught.**  
There is a risk of injury.
- **When moving the foot rest up and down, be careful that your fingers do not become caught in the connection.**  
There is a risk of injury.
- **When moving the back support up or down in order to adjust the back support height or for other reason, be careful that your fingers do not become caught in the bottom of the back support or the connection.**  
There is a risk of injury.

### CAUTION



- **When adjusting the device, grasp only the handle parts that are explained in this manual, and do not hold the device by any other areas.**  
There is a risk of injury caused when a hand become caught in the device.
- **Pay attention to the following and perform adjustment in order to ensure safe use.**  
There is a risk of unexpected accident.
  - Be sure to adjust the device to match the user's body before using it.
  - When adjusting, make sure to retighten the bolts.
  - Be sure to exit the device before performing adjustment.
  - Before performing adjustment, be sure to remove the battery from the device.

### 5.3.1. Adjusting the arm length

#### 1. Remove the arm cover.

Hold both the front-facing and rear-facing sides of the arm cover and gently bend them outwards then pull the arm cover towards you in order to remove it.



#### 2. While pulling on the arm length adjustment tab, slide the arm up or down to adjust it to the desired length.

Release the arm length adjustment tab at one of the four labelled positions to lock the arm in place and a click sound is heard.

The arm length can be adjusted in 4 stages.



- After adjustment is completed, try to slide the arm up and down to confirm that it is locked in place and does not slide.
- Do not touch the cable.

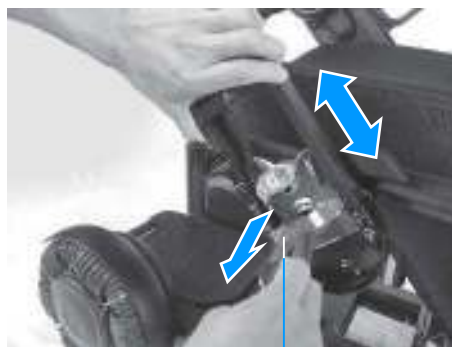

Arm length adjustment tab

3. Install the arm cover.  
Position the tabs on the front end and press the arm cover into place.



Be careful that the cable and arm length adjustment tab are not caught in the cover.



4. Adjust the arm length on the opposite side in the same way.

### 5.3.2. Switching the left and right sides of the directional controller assembly and control pad

The left and right side positions of the directional controller assembly and control pad can be reversed.

#### WARNING



- Do not touch the connectors or battery connectors, allow them to become wet, or bring any metal or other foreign objects close to them.  
There is a risk of injury and of damage to the device or its parts.



- Be sure to remove the battery before performing adjustment.  
There is a risk of electric shock and unexpected device operation.



- Do not place a load on the directional controller assembly or scratch it with a sharp object.  
There is a risk that the directional controller assembly may be damaged, rendering the device inoperable.
- Do not throw, step on, or otherwise subject the removed control pad or directional controller assembly to strong impact, and do not immerse these parts in water.  
There is a risk that the switch or directional controller assembly may be damaged, rendering the device inoperable.
- Do not scratch the display or touch it with dirty hands.  
There is a risk that the display information may become unreadable.
- Do not disassemble the control assemblies.  
Doing so may cause malfunction of the control assemblies.



- Pay attention to the following while adjusting.  
There is a risk of damage to the the device or its components.
  - Do not shake the removed control assemblies.
  - Do not press forcefully on the components.

**⚠ CAUTION**

- If a part is lost, immediately discontinue use and contact your distributor.  
There is a risk of damage to the device that renders it inoperable.

**1. Remove the battery.**

For the removal procedure, refer to “5.4.1 Removing the battery”.

**2. Remove the arm cover.**

For the removal procedure, refer to Step 1 in “5.3.1 Adjusting the arm length”.

**3. Rotate the inside cover counterclockwise and remove it.**

4. Remove the directional controller assembly or control pad.

- 1) Press down the white lever on the inside of the control assemblies.
- 2) Slide up the control assemblies.
- 3) Slide the box toward the inside to remove it.



When removing the control assemblies from the arm, do not pull forcefully on it. There is a risk of breaking the cable that is connected to it.



Lever

5. Disconnect the connector.

- 1) Rotate the connector base lock counterclockwise to loosen it.  
The lock is released.
2. Pull out the connector.



When disconnecting the connector, do not pull forcefully on control assemblies. There is a risk of breaking the cables.



Unlock

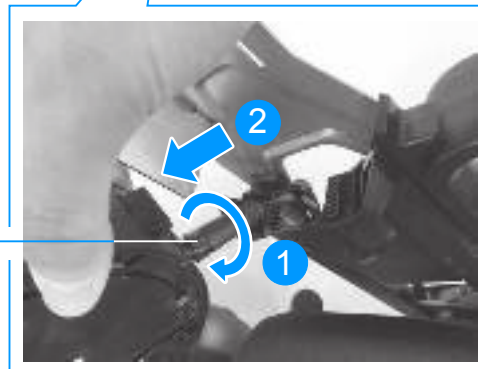

6. Rotate the outside ring-shaped cover counterclockwise and remove it.



Cover



7. Install the ring-shaped cover that was removed in the previous step onto the inside of the control assemblies (opposite side). Align the box “|” with the cover “▲” and rotate clockwise to fasten in place.



8. Repeat Steps 2 - 7 and move the ring-shaped cover on the opposite-side box in the same way.
9. Switch the location of control assemblies. Insert the connector and rotate the base lock clockwise to lock it. Rotate the lock until a click sound is heard.



10. Install the control assemblies onto the arms.
- 1) Slide the control assemblies onto the arm.
  - 2) Slide control assemblies downward. When a click sound is heard and the white lever rises, the box is fastened in place.



Move control assemblies up, down, left, and right, and check that it is locked in place.

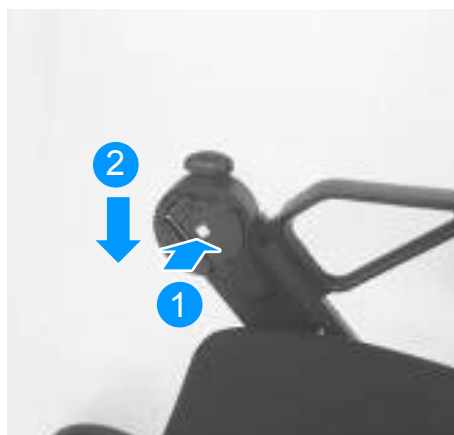

11. Rotate the inside cover clockwise to install it.

Align the box “|” with the cover “▲” and rotate clockwise to fasten in place.



12. Install the arm cover.

Position the tabs on the front end and press the arm cover into place.



Be careful that the cable and arm length adjustment tab are not caught in the cover.



13. Install the battery and check that the rear tail light illuminates for several seconds.

For the installation procedure, refer to “5.2.4 Installing the battery”.



If the rear tail light flashes, there may be a problem with the battery connectors. Check the connectors again.



Rear tail light

14. Turn on the power and check that the device moves forward, backward, left, and right without problems.



If an error appears on the display, check “9. Troubleshooting”. If the problem is still not solved, contact your distributor or WHILL Customer Support.

### 5.3.3. Adjusting the seat height

#### ⚠ WARNING



- Do not touch the battery connectors, allow them to become wet , or bring any metal or other foreign objects close to them.

There is a risk of injury and of damage to the device or its parts.



- Be sure to remove the battery before performing adjustment.

There is a risk of electric shock and unexpected device operation.

#### ⚠ CAUTION



- When adjusting the seat height, do not pull forcefully on the seat post.

There is a cable inside the seat post. Pulling forcefully on the seat post may break the cable inside it.

- Do not press a sharp object against or apply a load to the seatback cables located on the bottom of the seat assembly.

There is a risk of breaking the cables.



Seatback cables

1. Remove the battery.

For the removal procedure, refer to “5.4.1 Removing the battery”.



2. Remove the seat assembly.

For the removal procedure, refer to “5.4.2 Removing the seat assembly”.



3. Use a hex wrench (#8) and remove the seat post bolt.

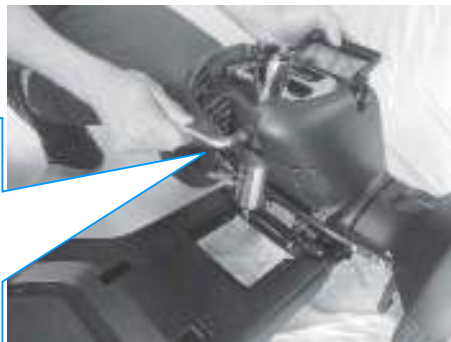
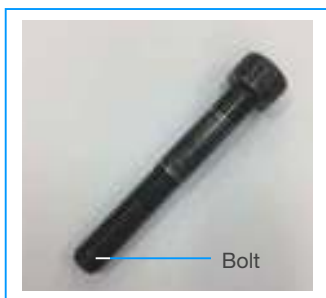

4. Move the seat post up or down and align with the hole that you want to adjust it to. The seat height can be adjusted in 5 stages.



There is a cable inside the seat post. Pulling forcefully on the seat post may pull and break the cable inside it.

Be careful not to forcefully pull on the seat post.

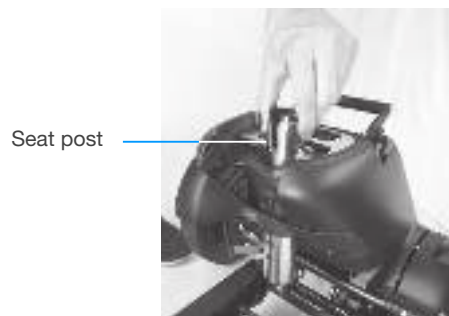

5. Insert the bolt that was removed in Step 3 into the hole at the desired height and tighten it securely.

Tightening torque: 25 Nm

The seat post is fastened in place.



6. Install the seat assembly.

For the installation procedure, refer to “5.2.3 Installing the seat assembly”.



7. Install the battery.

For the installation procedure, refer to “5.2.4 Installing the battery”.



### 5.3.4. Adjusting the back support height

- 1. Remove the back cushion.**  
Disconnect the velcro, and tilt the back cushion towards the rear.
- 2. Use a hex wrench (#4) and loosen the 4 bolts.**  
It is not necessary to remove the bolts all the way.
- 3. Move the back support up or down to adjust it.**
- 4. When it is at the desired height, tighten the loosened bolts.**  
Tightening torque: 10 Nm  
The back support is fastened in place.
- 5. Install the back cushion.**  
Return the back cushion to its original position and fasten it with the velcro fastener.



### 5.3.5. Adjusting the back support angle

1. Remove the seat cushion.



2. Tilt the back support forward slightly.



3. Lift up the adjustment block while turning it and adjust to the correct angle.  
The back support can be adjusted in 3 stages (90°, 95°, 100°).



Adjust the left and right blocks to the same angle.

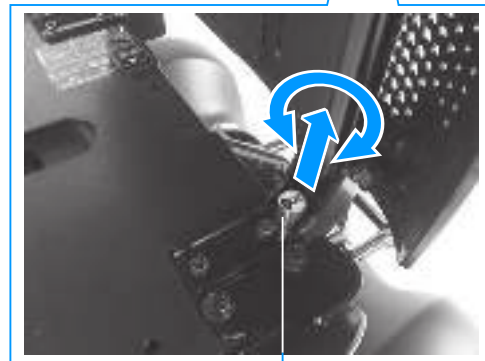

Adjustment block

4. Install the seat cushion.

## 5.4. Disassembly Procedures

Disassembly of the device does not require tools. When disassembling the device, pay careful attention to the following.



For the methods of transporting the disassembled components, refer to “6.2 Transport”.

### WARNING

	<ul style="list-style-type: none"> <li>● <b>When disassembling the front drive base and rear drive base, be sure to grasp the handle A.</b> There is a risk of injury caused if fingers are caught in the disassembly mechanism.</li> <li>● <b>Perform disassembly in a flat, level location.</b> There is a risk of unexpected accident.</li> </ul>
	<ul style="list-style-type: none"> <li>● <b>Do not touch the battery connectors, allow them to become wet , or bring any metal or other foreign objects close to them.</b> There is a risk of injury and of damage to the device or its parts.</li> </ul>
	<ul style="list-style-type: none"> <li>● <b>Be sure to remove the battery before performing disassembly.</b> There is a risk of electric shock and unexpected device operation. In addition, if the device is disassembled without the battery removed, there is a risk that the device may be reset due to metal contact with exposed connectors. If the device is reset, disconnect the battery and then reconnect it.</li> </ul>

### CAUTION

	<ul style="list-style-type: none"> <li>● <b>When disassembling the device, grasp only the handle parts that are explained in this manual, and do not hold the device by any other areas.</b> There is a risk of injury caused when a hand become caught in the device.</li> </ul>
--	---



### 5.4.1. Removing the battery

1. Check that the device power is off.
2. Insert the key into the keyhole at the top of the battery and turn the key to unlock the battery.



Keyhole

3. Grasp the handle and pull it toward you to remove the battery.  
Pull the handle toward you and lift up the battery to disconnect it from the projections at the bottom.



The battery weighs 6.2 lbs ( 2.8 kg) . Be careful not to drop it when removing it. There is a risk of injury or damage caused by the battery dropping.



Projections

## 5.4.2. Removing the seat assembly

### ⚠ WARNING



- Persons who have an implanted pacemaker, implanted defibrillator, or other electrical medical device on their bodies must stay a minimum of 8 inches (20 cm) away from the magnetic connectors.

The magnetic connectors are located at the connection between the seat assembly and rear drive base, and the connection between the battery and rear drive base. The magneticism of the magnetic connectors may have an adverse effect on electrical medical devices.



- Do not sit on the controller knob, place the removed seat upside down, or apply an excessive load to the controller knob.

There is a risk that the controller knob may be damaged, rendering the device inoperable.

### ⚠ CAUTION



- Do not press a sharp object against or apply a load to the seatback cables located on the bottom of the seat assembly.

There is a risk of breaking the cables.



Seatback cables

1. If the storage basket is installed, unfasten the storage basket hook from the accessory bar.



2. Pull the seat release lever on the bottom of the seat assembly toward you.



Use caution because if you place a knee on the foot rest or otherwise apply weight to it, the device may tip over.

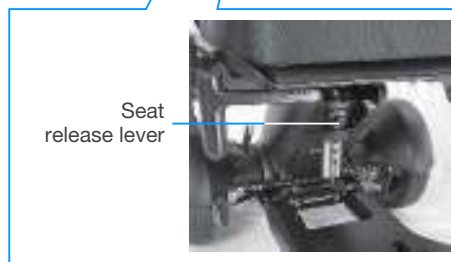

3. Grasp the arm rests and lift the seat assembly straight up to remove it from the Rear drive base.



Lift up the seat assembly slowly so that it does not contact other parts.



4. Set the removed seat assembly on the floor with the cushion side facing up.



### 5.4.3. Removing the storage basket

1. Remove all items that are in the storage basket.
2. Lift up the storage basket and disconnect the velcro fastener that is on the bottom of the front drive base.
3. Lift up the storage basket while rotating it toward you to disengage it from the rear drive base hook.



### 5.4.4. Removing the front drive base

1. Pull the base release lever toward you to release lock between the front drive base and rear drive base.



2. Grasp handle A and disengage handle B from the hook of the rear drive base.



Support the rear drive base with a hand while disconnecting so that the rear drive base does not fall over.

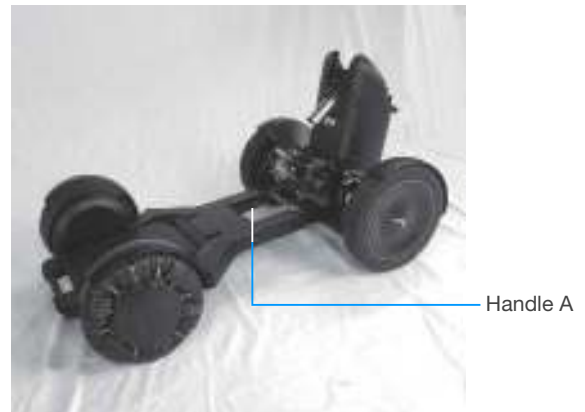

3. Place the disassembled front drive base and rear drive base as shown in the photo at right.



A large rectangular area consisting of 20 vertical blue lines, providing a grid for notes or diagrams.



## 6. Transport and Storage Methods

### 6.1. Storage

Pay attention to the following when storing this device.

- Do not store it in close proximity to flammable gas.
- Store in a location with an ambient temperature of -15°C and 40°C ( 5 °F and 104°F).
- Do not lay the device on its side.

#### CAUTION

	<ul style="list-style-type: none"> <li>● <b>Store the device in a flat location.</b> There is a risk of damage to the device.</li> </ul>
	<ul style="list-style-type: none"> <li>● <b>Do not store the device for long periods in a location where there is much dust or sand, near the ocean, or in a hot spring area.</b> There is a risk of foreign substances entering the device and corroding the frame and screws.</li> <li>● <b>Do not store the device with a heavy object placed on it for a long period of time.</b> There is a risk of device malfunction.</li> <li>● <b>Do not store the device or storage basket outdoors in a location exposed to direct sunlight or rain.</b> There is a risk that rain may cause a short circuit, and that direct sunlight may cause deformation or deterioration of the device or storage basket. Store them indoors or in another location under a roof.</li> </ul>

#### ■ When storing for a long period of time

When storing for a long period (4 months or longer), remove the battery from the base. At least once every 3 months, charge the battery and check that the device operates correctly.

When using this device again after a prolonged period of disuse, charge the battery before using, and be sure to check that the device operates correctly before using it.

#### CAUTION

	<ul style="list-style-type: none"> <li>● <b>If the device is not used for a long period, be sure to charge it at least once every 3 months.</b> If it is left uncharged, there is a risk that the battery may become excessively depleted.</li> </ul>
---	---

## 6.2. Transport

Pay attention to the following when transporting this device.

- When carrying device by hand, grasp the designated handles and do not hold it by any other part.
- When using public transportation, follow the rules of the public transportation agency.

### WARNING



- **Be sure to disassemble the device before lifting it up.**

The weight of the device is approximately 115 lbs (52 kg). If it is lifted up without disassembly, there is a risk of bodily injury and/or device damage.

- **Be careful of the weight when lifting up each component.**

There is a risk of bodily injury and/or device damage.



- **Do not use the device as a seat in an automobile or other vehicle.**

There is a risk of damage to the device, causing an unexpected accident.

- **Do not lift up the device when there is a person on the device.**

There is a risk of damage to the device, causing an unexpected accident.

### CAUTION



- **When boarding an airplane, notify the airline company in advance that you will be using a personal electric vehicle, receive an explanation of the boarding procedure, and follow the instructions of the airline company.**

Failure to notify the airline in advance may result in additional time required for the boarding procedure.

- **Fasten securely when placing in an automobile trunk or similar location.**

There is a risk of damage to the device.

- **When using a forklift to transport this device, be sure to fasten the device securely.**

There is a risk of the device falling, causing damage to the device.



## 6.2.1. How to hold each component

When transporting the device disassembled, hold each component by the handles designated below.

### ■ Seat assembly

#### ⚠ WARNING



- Persons who have an implanted pacemaker, implanted defibrillator, or other electrical medical device on their bodies must stay a minimum of 8 inches (20 cm) away from the magnetic connectors.

The magnetic connectors are located at the connection between the seat assembly and rear drive base, and the connection between the battery and rear drive base. The magnetism of the magnetic connectors may have an adverse effect on electrical medical devices.



- Do not touch the battery connectors, allow them to become wet, or bring any metal or other foreign objects close to them.

There is a risk of injury and of damage to the device or its parts.

#### ⚠ CAUTION



- Do not press a sharp object against or apply a load to the seatback cables located on the bottom of the seat assembly.

There is a risk of breaking the cables.



Seatback cables

Carry by holding the arm rests.



When placing it on the floor, place it with the cushion side facing up.



Arm rest

### ■ Front drive base

Carry by holding the handle on the end of the foot rest and the handle A.



Foot rest handle

Handle A

### ■ Rear drive base

#### WARNING



- Do not touch the battery connectors, allow them to become wet, or bring any metal or other foreign objects close to them.

There is a risk of injury and of damage to the device or its parts.

Carry by holding the handle on top of the main body and the anti-tip bar.

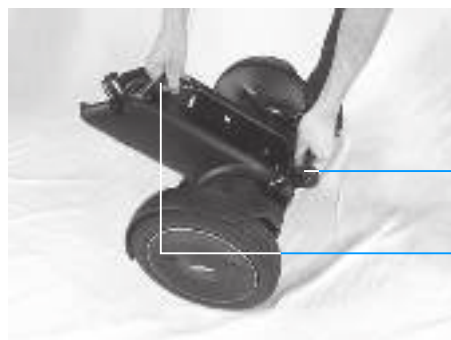

Anti-tip bar

Handle on top of main body

## 7. Downloading the Smartphone App

By installing the WHILL app on an Apple iOS device (such as an iPhone or iPad), it is possible to configure the device settings from the app. The app's remote control functions also makes it possible to move the wheelchair aside after use or to move it to a narrow storage space.

The following is an explanation of how to download and install this app.



Downloading the app may incur data charges.

1. From the home screen, tap [App Store].

The App Store appears.



2. Tap [Search].

The search window appears.



3. Enter “WHILL Model Ci” in the search field and tap [Search].



4. Tap [GET].  
The button changes to [INSTALL].



5. Tap [INSTALL ] and enter your password.  
Downloading begins. When the display changes to [OPEN], the app can be opened and used.



For the app login ID and password, refer to the last page of this manual.





#### Procedure for reissue of app password

Reissue of the app password can be requested through WHILL Customer Support.

## 8. Maintenance and Inspection

### WARNING

	<ul style="list-style-type: none"> <li>● Do not perform any disassembly, adjustment, or repairs that are not explained in this manual. If the customer performs such acts him/herself, there is a safety serious risk. Consult with your distributor when adjusting the seat length or arm position. Only a trained service technician can provide maintenance on the device.</li> </ul>
	<ul style="list-style-type: none"> <li>● Do not modify the device or its accessory parts. If repair or modification which is not listed in this manual is performed, the warranty may be invalidated.</li> </ul>

### 8.1. User Maintenance

Perform the following to keep the device clean.

- If there is significant dirt on the exterior or wheels, either wipe it away with a wet towel or wash it with water.
- If the dirt is stubborn, use a neutral detergent. Avoid the use of petroleum-based detergents.
- Do not use a high-pressure washer.

### CAUTION

	<ul style="list-style-type: none"> <li>● Do not use paint thinner, benzene, or other organic solvents for cleaning, and do not use a high-pressure washer. Doing so may result in discoloration, deformation, deterioration, and damage.</li> <li>● Do not insert a sharp object into the speaker holes. Doing so may damage the control pad.</li> <li>● Do not apply commercially available grease or similar substance to the moving parts or connections of the device. There is a risk that the stickiness of such substances may cause sand or other foreign substance to enter the device, causing device malfunction.</li> </ul>
---	---

## 8.2. Replacing the Smart Key Battery

When the display indicates that the smart key battery level is low, follow the procedure below and replace the smart key battery.

Use a CR2032 3V battery (commercially available) for the button battery.



For the messages shown on the display, refer to “9. Troubleshooting”.

1. Insert a flathead screwdriver into the hole in the case and remove the case.

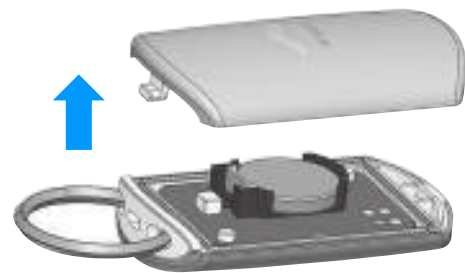

2. Pull back the terminal and remove the old battery from the battery case.

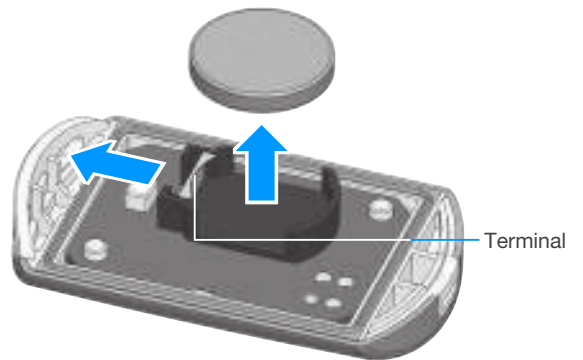

3. Pull back the terminal and install a new battery under the rib in the battery case.

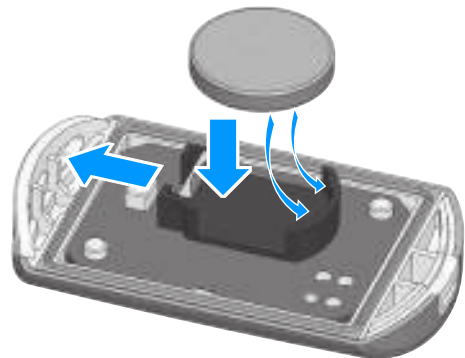

4. Install the case.
  - 1) Insert the tab into the hole.
  - 2) Press the opposite side of the case with the WHILL logo on it in order to fit it into place.

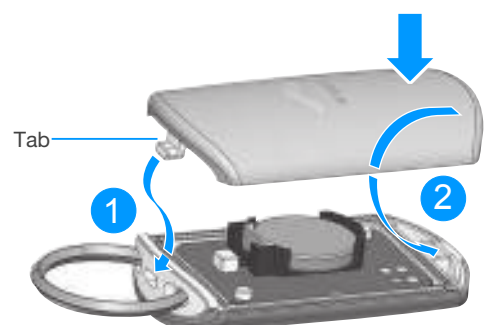

### 8.3. Reinstalling the Controller Knob

If the controller knob comes off of the directional controller assembly, follow the procedure below to reinstall it.

1. Fit the controller knob in place 90° relative to the direction of forward travel.



2. Rotate the controller knob clockwise by 90°.



## 8.4. Inspection

It is recommended that you have it inspected approximately once every 6 months by your distributor. For details, consult your distributor.

## 8.5. Repairs, Maintenance, and Parts Replacement Performed by the Manufacturer or Distributor

If repair, maintenance, or part replacement is necessary, contact your distributor or WHILL Customer Support. The following maintenance can be performed by the distributors.

- Adjustment of the foot rest angle
- Adjustment of the seat length
- Adjustment of the arm position
- Replacement of the back support
- Installation of a lap belt

The following components can be removed from the device and repaired individually.

- Seat assembly
- Rear drive base
- Front drive base
- Charger (provided device)

For details, please contact your distributor or WHILL Customer Support.

### WARNING



- **Be sure to replace the anti-tip bar if it become deformed.**  
There is a risk that it may lose its tip-over prevention function and the device may tip over.

### CAUTION



- **If a part becomes worn or requires replacement, contact your distributor.**  
There is a risk of damage to the device that renders it inoperable.



## 8.6. Disposal

### ⚠ CAUTION



- When disposing of the device and its parts, be sure to follow the local disposal guidelines. If there is anything that is unclear, consult your distributor or WHILL Customer Support.





The device, the battery, and the accessories are durable devices. Failure to dispose of waste items in accordance with laws and regulations may result in release of substances that are harmful to the environment. This label (illustration on the left) indicates that this device must be recycled in accordance with European Directive 2012/19/EC (WEEE Directive). In order to protect the environment, when the device lifetime is reached, have the device collected by the local recycling center. Because the WEEE Directive does not apply to all countries in Europe, follow the regulations in that country when disposing of the device.



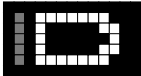
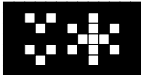

## 9. Troubleshooting

In the event of certain issues with the device, an error message will appear on the display.

The following is an explanation of the error display contents, guidance, causes, and corrections.

Problem	Display indication	Interpretation of error code	Cause(s)	Correction
The power turns off when the device stops	01	Lower the arm and turn the power on again	The directional controller was operated while the arm was rotating	Lower the arm.
	02	Turn the power on again without touching the directional controller	The directional controller was not in neutral position when the power was turned on.	Power back ON without touching the directional controller
	03	Raise the red lever on the side of the device and turn the power on again	The brakes was released	Lock the brakes.
		-	The charger was connected while the power was on, or the device was turned on while charging.	Disconnect the charger.
The display shown at right appears		-	Low battery	Recharge the battery.
The speed is slow		Speed is restricted because of low battery temperature	The battery is in low temperature mode (below 0°C (32° F))	Move to a location where the temperature is higher than 0°C (32° F)
The speed suddenly increases		The speed restriction due to low battery temperature was canceled	Low temperature mode is off (battery temperature has reached above 0°C (32° F))	-

Problem	Display indication	Interpretation of error code	Cause(s)	Correction
The guidance and display shown at right occur		The inclination angle is greater than 10°	The device may be on a slope of 10° or greater.	Move to a location where the inclination angle is 10° or less. This notification disappears after a certain length of time (5 minutes or more). Drive slowly while being careful to avoid steep slopes.
		Replace the smart key battery	The smart key battery level is low	Replace the smart key battery.



- The error message number shown in the display appears together with a red vertical line.
- If an error not in the above list appears, contact your distributor or WHILL Customer Support.



Red line

# 10. Specifications and Test Results

## 10.1. Specifications

### ■ Device

Item	Specification
Drive type	2-wheel drive
Speed changes	4 stages
Brake type	Electromagnetic brakes
Front wheel type	Omni-Wheel
Rear wheel type	Solid tires
Arm	Lift-up type
Maximum allowable inclination	10°
Cruising distance	Maximum 10 miles (16 km)
Maximum load	253 lbs (115 kg)
Rear tail light	LED lamp (red)
Charging time	5 hours
Service environment	-15 to 40°C (5 to 104 °F)
Pivot width	30 inches (760 mm)
Estimated service lifetime	5 years
Noise produced by the device and level thereof	Below 65dBA except audible warning device

### ■ Battery

Item	Spec
Battery type	Lithium-ion battery
Nominal voltage	25.2 V
Rated capacity (5-hour rate)	10040 mAh
Name and address of the battery charger manufacturer	WHILL, Inc. 285 Old Country Rd #6 San Carlos, CA 94070

## ■ Charger

Item	Spec
Rated input voltage	100-240 V
Rated DC output current	2.6 A
Rated DC output voltage	29 V
Service environment	0 to 40°C (32 to 104 °F)
Supported battery type	Lithium-ion battery
Rated capacity of charged battery (5-hour rate)	10040 mAh
Environmental protection grade	IPX4
Connector pin allocation	Pin1: + Pin2: - Pin3: Detection Pin4: Non connected
Type reference of the battery charger;	Off-board battery charger
Rated current of any user-accessible protective fuses	There are no user-accessible fuses.
Name and address of the battery charger manufacturer	WHILL, Inc. 285 Old Country Rd #6 San Carlos, CA 94070

## 10.2. Dimentions

This device satisfies all requirements of ISO 7176-14.

### ■ Basic information

Device name	: WHILL Model Ci
Manufacturer	: WHILL, Inc.
Address	: 285 Old Country Rd #6 San Carlos, CA 94070
Maximum user weight	: 253 lbs (115 kg)

### ■ Device

Item	Minimum value	Maximum value
Total length (including foot rest)	-	38.85 inches (985 mm)
Total width	-	16" -21.5 inches (550 mm) 18" -23.5 inches (600 mm)
Device weight	-	Approximately 115 lbs (52kg)
Heaviest removable component (Rear drive base)	-	44 lbs (20 kg)
Cruising distance	-	Maximum 10 miles (16 km)
Obstacle drive-over height (forward driving)	-	2 inches (50 mm)
Maximum forward speed	-	5 mph (6 km/h)
Seat angle	-	6°
Effective seat length	14.8 inches (375 mm)	16.7 inches (425 mm, 3 stages)
Effective seat width	-	16 inches (400 mm) 18 inches (460 mm)
Ground height of seat front edge	17.5 inches (445 mm)	20.7 inches (525 mm)
Back support angle	90°	100° (3 stages)
Back support height	29.1 inches (740 mm)	37 inches (940 mm, stepless)
Height from foot rest to seat assembly	13.2 inches (337 mm)	16.4 inches (417 mm)
Angle of seat and legs	-	84°
Distance from arm rest to seat	9.6 inches (245 mm)	12 inches (305mm, 4 stages)
Front-rear position of arm rest	-	16.6 inches (422 mm)
Horizontal position of axle	-	1.1 inches (28.8 mm)
Minimum turning radius	-	30 inches (760 mm)
Seat weight	-	32 lbs (14 kg)
Rear drive base weight	-	44 lbs (20 kg)
Front drive base weight	-	32 lbs (14 kg)
Battery weight	-	6.2 lbs ( 2.8 kg)





# Index

<b>A</b>	
Accessories .....	30
Accessory bar .....	57
Adjusting the maximum speed.....	49
Adjusting the speed .....	53
Adjustment procedures.....	70
Anti-tip bar.....	29
App.....	91
Arm.....	26, 96
Adjusting the length.....	71
Arm rest.....	26
Assembly procedures.....	64
Storage basket .....	65
Battery .....	69
<b>B</b>	
Back support.....	26, 57, 96
Adjusting the angle .....	81
Adjusting the height.....	79
Base release lever .....	29
Battery.....	29, 31, 32, 63
Charging .....	33
Checking the charge level .....	38, 49
Error displays.....	38
Installation.....	69
Maintenance, inspection, and replacement.....	40
Power/charge indicator .....	37
Removal.....	83
Battery charging.....	31
Battery installation.....	69
Battery removal .....	83
Boarding.....	44
Brakes .....	55
Brake release levers .....	28, 55
<b>C</b>	
Charge level.....	38, 49
Charge level indicator.....	32, 38
Charger.....	29, 32, 96
Charging.....	60
Charging procedures.....	33
Contact information.....	106
Control pad .....	27, 72
<b>D</b>	
Dimensions.....	102
Directional controller assembly .....	26, 53
Switching the left and right sides .....	72
Disassembly procedures.....	82
Storage basket .....	85
Battery .....	83
Display.....	27, 98
Disposal.....	97
Driving .....	50
<b>E</b>	
Electromagnetic interference.....	16
EMI .....	16
Error displays .....	38, 98
Error messages .....	98
<b>F</b>	
Foot rest .....	28, 96
Front drive base .....	62, 64, 86, 90, 96
Front omni-wheel .....	28
Functions of parts .....	25
<b>H</b>	
Holding the device .....	89
Horn.....	27, 49
<b>I</b>	
Inspection.....	93, 96
Inspection before getting into the device.....	42
<b>L</b>	
Labels.....	18
Lap belt .....	47, 96
Locking the device .....	58
Login ID .....	106
<b>M</b>	
Magnetic connectors.....	66
Maintenance.....	93, 96
Moving.....	50, 52
<b>N</b>	
Names of components.....	25, 62

<b>O</b>	
Omni-wheel .....	28
Operating procedures .....	41
<b>P</b>	
Parts replacement .....	96
Password.....	106
Power button.....	27, 48
Power/charge indicator .....	37
Precautions for use .....	16
<b>R</b>	
Rear drive base .....	63, 64, 86, 90, 96
Rear tail light.....	28
Rear wheels.....	27
Reinstalling the directional controller assembly .....	95
Releasing the brakes.....	55
RFI.....	16
<b>S</b>	
Safety precautions .....	6
Seat assembly .....	62, 66, 83, 89, 96
Adjusting the height.....	77
Seatback cables.....	66
Seat post .....	78
Seat release lever.....	27, 68
Serial number .....	24
Smart key .....	29, 58
Replacing the battery.....	94
Smartphone.....	60, 91
Smartphone app.....	91
Speaker .....	27
Specifications.....	100
Speed select buttons .....	27, 49
Stopping.....	53
Storage.....	87
Storage basket .....	27, 57, 63, 65, 85
<b>T</b>	
Test results.....	100
Transport .....	88
Troubleshooting .....	98
Turning .....	52
Turning On the power.....	48

<b>U</b>	
USB port.....	28, 60
User maintenance .....	93
<b>W</b>	
Warning labels.....	18
Warranty .....	105

# About the Warranty

Get warranty information from WHILL US Sales.

# Contact Information

The distributor where this device was purchased will handle requests for repair, maintenance and parts replacement. To determine whether or not a loaner device is provided during servicing, contact the distributor.

## ■ Distributor

## ■ Manufacturer

WHILL, Inc.

## ■ App login ID and password