

Design your own road

[www.whill-europe.com](http://www.whill-europe.com)

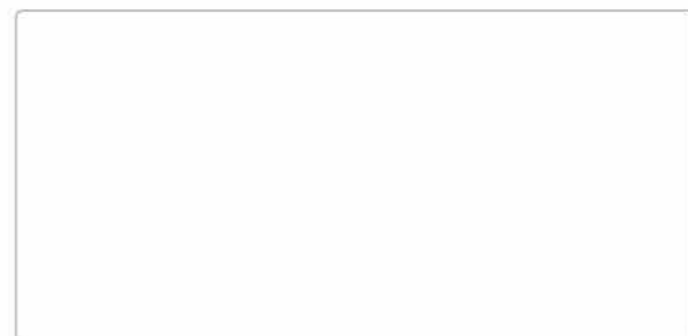

EU Office | WHILL Europe B.V.  
Johan Cruijff Boulevard 61 1101 DL  
Amsterdam The Netherlands

REF 743-0027



CE



# WHILL Model C

## Enjoy Life on New Wheels

\*Model C can be manoeuvred on pavements.

Enjoying the outdoors, meeting friends, capturing the seasons change, and going shopping for dinner are the ordinary events of everyday life.

WHILL Model C has been designed and engineered to help you enjoy them the easy way.

'If only I could load it into the car easily and go much farther.'

'Being able to choose a colour that suits my style would surely make me want to go outside more often.'

Convenience, freedom, style...these are just some of the things everyone longs for in their daily lives.

This new mobility device is packed up with cutting-edge technology and ideas to end your longing.

What we propose you with WHILL Model C is not a means of transport, but a brand-new lifestyle.





Omni-wheels  
Allow for in-place rotation.

## Convenient

### Smaller Turning, Greater Adaptability

Convenience comes with the ability to go to different places. This is why we have developed the special front omni-wheels, which allow both rotation and sideways motion. Boasting cutting-edge technology, WHILL Model C is engineered to enhance your lifestyle from the little things like daily shopping. WHILL Model C is engineered to enhance your lifestyle indoors, as long as you feel comfortable driving a powered device.

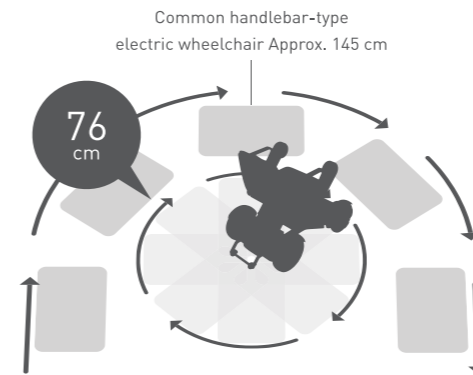

The omni-wheels are one-piece tyres fitted with a set of 24 small rollers. Each roller moves sideways enabling a 76 cm circular turn.

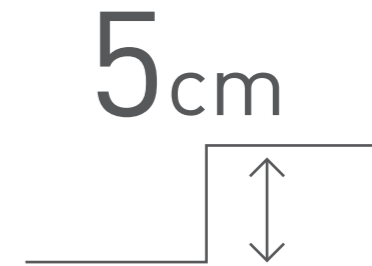

Thanks to its large front wheels and high-output motor, Model C can clear obstacles as high as 5 cm.

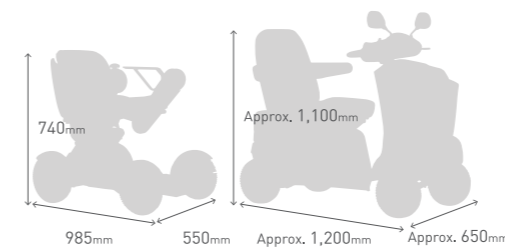

Its compact frame (width 550 mm x length 985 mm x height 740 mm) sets you up for a comfortable ride both indoors and out.

\*Whilst common handlebar-type electric wheelchairs feature: Approx. 650 x 1,200 x 1,100 mm (W x L x H)

# Portable

## Easily Dismantle and Transport in Just 4 Steps

Want to go out in the car with your family? Give no second thoughts! WHILL Model C is designed to easily dismantle and load into any car. Because we want you to embrace the freedom to not just move freely around the house, but to travel further afield. Whether it is shopping at the weekend, or going on a family trip, WHILL Model C takes you to whole new horizons.

Trans portable

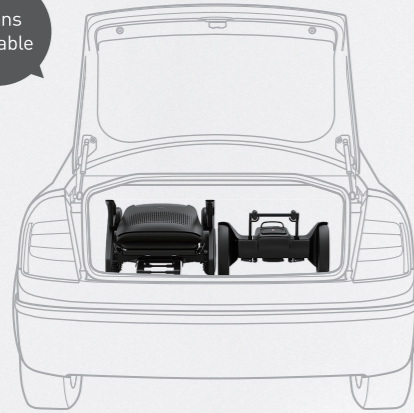

Fits also into a saloon-type boot. \*  
Reassemble when at your destination and you are free to safely explore the surroundings.

Space saver



\*Images shown above are for illustrative purposes only.

Easy to dismantle

Use the levers to easily dismantle into three parts.

### Step 1

Remove the battery



### Step 2

Pull up on the lever under the seat.



### Step 3

Pull out the seat.



### Step 4

Pull the lever next to the battery towards you to separate into the rear drive base and front drive base.





# Easy & Safe

## Designed With the User Foremost in Mind

We set out to create a mobility device that allows both children and adults to use safely and transfer easily. The safety brake and downhill turning prevention control are in place to make sure you enjoy a safe drive even on inclines.

Easy to operate



Model C offers complete control over your movements with zero effort. Use just your fingertips to drive back/forth and left/right.

Easy transfer



The armrests can be flipped up which allows for an easy transfer. You can even stand on the footrest and not fall.

Safety brake

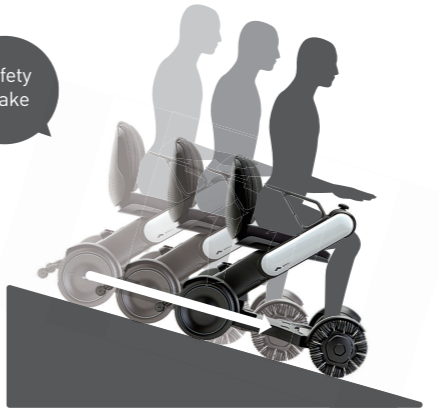

Remove your hand from the controller and brakes will be applied automatically to make your descent safer.

No downhill turning

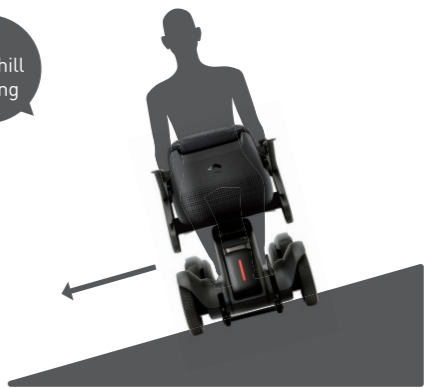

The dual motor system controlling both sides keeps your ride straight over cross sloped surfaces.



## More features

### Enhanced Versatility for a Bespoke Design

Packed with multiple features, WHILL Model C provides mobility in a safer and more convenient way. Connecting the model to your smartphone\* via Bluetooth®LE allows you to fine-tune the speed and acceleration settings and even to control remotely. Not to mention that thanks to its detachable lightweight battery you get to choose where to recharge it. Finally, with the voice guidance detecting steep ascents and a wireless key for easy operation, you are tuned up for a safe ride. (\*) You will need to install the application beforehand.

APP



Model C can be steered hands-free.  
Just keep in mind that this device is intended to be operated solely by its occupant.

Smooth ride

Model C uses two high-output in-wheel motors – developed in cooperation with Nidec Corporation. This provides a smooth ride even at very low speed.



Charging

#### Lightweight Battery

Equipped with a 2.8 kg lightweight battery (Panasonic).  
Can be removed and charged at home. (Lithium-ion battery)



Removing the battery has never been easier!  
Just pull on the lever and lift up.

5 hours to charge  
15km driving range

1000 cycles Long Battery Life

\*Based on in-house tests.  
\*The values shown are indicative only and not guaranteed in any way.  
\*The actual service life of the battery will vary based on factors such as air temperature, usage and driving conditions.

You can check battery level at a glance.

2.8kg lightweight



Voice guide



#### Voice Guidance for Safety

A voice message will be played automatically to warn you of possible danger such as steep slopes.

Easy lock



#### Smart Key

Wireless lock is available. (standard feature)

# Options

You get to choose from a variety of options.

Pick your favourite colour from the six features below.



## Specifications

Max. Driving Range	15km <small>Depends on road conditions</small>	Charging Time	5 hours
Max. Speed*	6km/h	Front Tyres	Omni-wheels
Max. Obstacle Height	5cm	Rear Tyres	Solid tyres
Climbing Ability	10°	Arms	Flip-up type
Turning Radius	760mm	Max. Load	115kg
Overall Dimensions (W x L x H)	550×985×740-940mm	Battery	Lithium-ion (25.2V 10.0Ah)
Net Weight	Approx. 52kg	Operating Conditions**	-15°C~40°C

\*Speed may be restricted by steep slopes. \*\*When battery temperature drops significantly, the maximum speed may be restricted.

# Fitting

## Make It Your Own

Seat depth and height, back support height and angle, controller height, arm position – customise it as you wish to best suit your needs.

Note that these options have to be installed by an authorized technician.

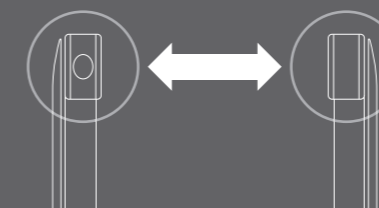
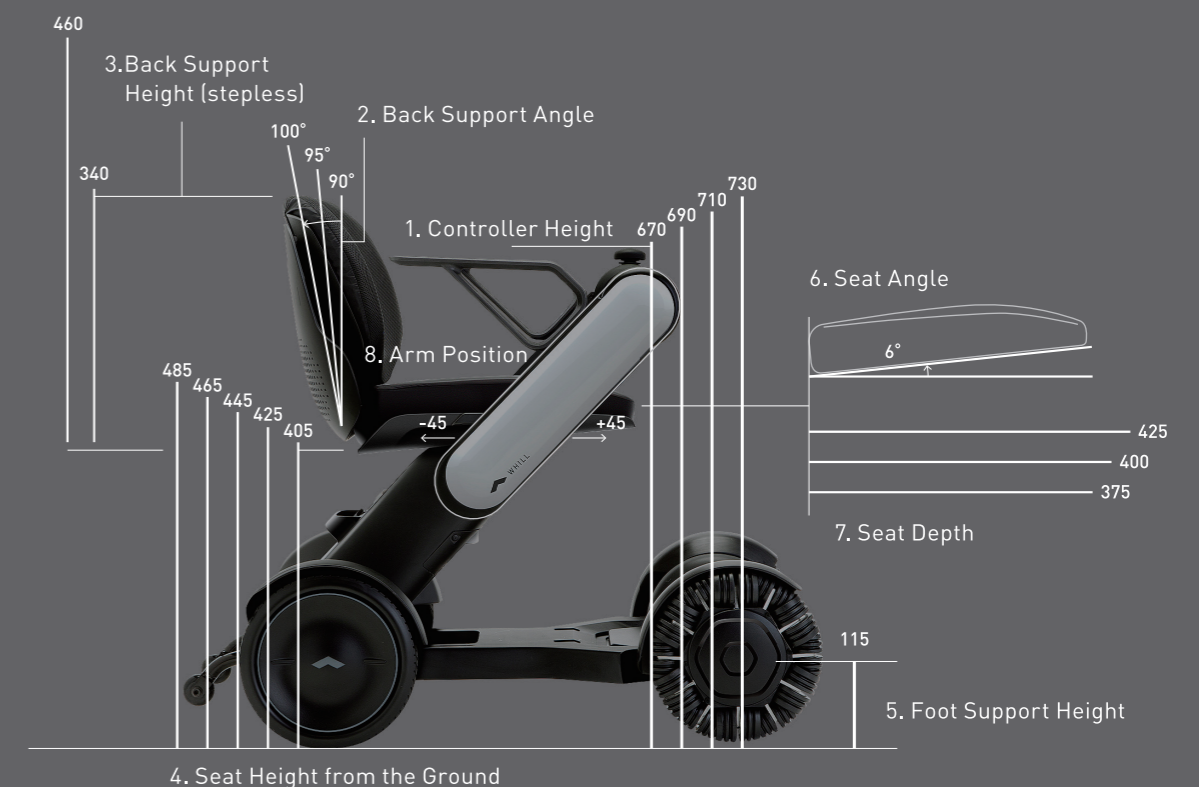

The controller can be configured on the right or left side.

- 1. Controller Height ..... 670, 690, 710, 730mm
- 2. Back Support Angle ..... 90, 95, 100°
- 3. Back Support Height ..... 340 - 460mm (stepless)
- 4. Seat Height from the Ground ... 405, 425, 445, 465, 485mm
- 5. Foot Support Height ..... 115mm
- 6. Seat Angle ..... 6°
- 7. Seat Depth ..... 375, 400, 425mm
- 8. Arm Position ..... -45, 0, +45mm

