

Model M

User Manual





**USER MANUAL
MODEL M**

R_xonly



USER MANUAL MODEL M

Table of Contents

1	Introduction	3
1.1	Welcome	3
1.2	Manual Overview	3
1.3	Notations	3
1.4	Document Guidelines	4
1.4.1	Illustrations.....	4
1.4.2	Product Specifications	4
1.4.3	Errors and Omissions	4
1.5	Intended Use	4
2	Safety	5
2.1	Warnings	5
2.2	Cautions	10
3	Product	11
3.1	Model M Components	11
3.2	Arm and Seat Positions.....	12
3.3	Cushions	13
3.4	Specifications	13
3.5	Dimensional Information	14
3.6	Test Information	15
4	Operation	16
4.1	Safety Check	16
4.2	Transfers into and out of the chair	17
4.3	Lap Belt	20
4.4	Power Switch	21
4.4.1	Turning the Model M On.....	21
4.4.2	Turning the Model M off.....	22
4.5	Checking the Battery Charge Level	22
4.5.1	Lights showing full battery charge	22
4.5.2	Lights showing intermediate charge level.....	23
4.5.3	Low battery indication	23



USER MANUAL MODEL M

4.6	Speed Control	24
4.6.1	Speed Setting	24
4.6.2	Speed control through the directional controller	25
4.7	Directional Controller	25
4.8	Safety Check when Starting to Move	27
4.9	Driving Conditions	28
4.10	Stopping and Parking.....	31
4.11	Sitting at a Table or Desk.....	31
5	Brake Release Levers	32
5.1	How to release the electromagnetic brakes	33
5.2	How to engage the electromagnetic brake(s)	34
6	Battery and Charging	35
6.1	Charger specifications for WHILL Model M.....	36
6.2	Charging the battery.....	38
6.3	Battery service or replacement	40
7	Electromagnetic Interference (EMI)	40
7.1	EMI Sources.....	41
7.2	EMI Guidance Tables.....	41
8	Troubleshooting	46
9	Maintenance.....	46
10	Transport Option.....	47
10.1	Using the Transport Option.....	49
10.2	Proper Occupant Restraint	52
10.3	Clear Zones	54
11	Symbols.....	56
12	Warranty	59
13	Customer Support	60

1 Introduction

1.1 *Welcome*

Welcome to your new WHILL device! The Model M has amazing features that we hope will positively change the way you live your daily life.

The following items are provided to you:

- WHILL Model M powered wheelchair
- WHILL mobility device charger (High Power off-board battery charger)
- User Manual (printed or digital copy of this manual)



CAUTION

CAUTION: Federal (USA) law restricts this device to sale by or on the order of a physician.

1.2 *Manual Overview*

This User Manual provides relevant guidelines for the WHILL Model M on how to safely use important features of the device, such as the speed and directional controllers. It also provides basic service, troubleshooting, and maintenance information.

The manual may also be used by dealers, resellers, sales people, and others who wish to understand important features of the device in more detail.

At WHILL, we care about your safety and experience with our products. Please carefully read and follow all the instructions in this manual.

1.3 *Notations*



WARNING

Indicates a hazardous situation that, if not avoided, could result in death or serious injury.



CAUTION

Indicates a hazardous situation that, if not avoided, may result in property damage, minor injury, or both.



INFORMATION

Gives useful tips, recommendations and information for efficient, trouble-free use.

1.4 ***Document Guidelines***



INFORMATION

THE INFORMATION CONTAINED IN THIS DOCUMENT IS SUBJECT TO CHANGE WITHOUT NOTICE.

1.4.1 *Illustrations*

The illustrations provided in this manual are for demonstration and conceptual visualization purposes only. Your actual product might vary from the illustrations in the following ways:

- The directional controller (joystick) may be on either the left or right arm.
- There are different shapes for the directional controller.

1.4.2 *Product Specifications*

All specifications and descriptions contained in this manual are verified to be accurate at the time of printing.

1.4.3 *Errors and Omissions*

Please send an email to: support@whill.us if you notice any inaccuracies or omissions in this manual.

1.5 ***Intended Use***

The intended use of the WHILL powered wheelchair is to provide indoor and outdoor mobility to persons limited to a seated position that are capable of operating a powered wheelchair.

The chair supports a maximum weight of 220 lbs.

2 Safety

2.1 Warnings



WARNING

Model M operation

- Do not operate the Model M without first reading this user manual. Please pay close attention to all safety information and warnings. Contact customer support if you need any clarification on sections that are unclear. Failure to read and understand how to properly operate the Model M may result in damage and/or injury.
- The weight capacity of the Model M is 220 lbs. To avoid injury or Model M failure, do not exceed this weight.
- Do not operate the Model M if the battery is depleted as you could be stranded.
- Do not use the device if there are broken components as you could be injured by sharp edges or exposure to moving parts.
- Do not operate the Model M on any streets, roads, or highways. Operating the Model M on streets, roads, or highways may expose you to situations that may result in severe damage and/or injury. Before crossing the street, make sure that any and all drivers see you.
- Do not use the Model M if it has been exposed to excessive water, is damaged in any way, or requires service. Contact WHILL or reseller for service.
- To prevent injury and/or damage, do not use the Model M in heavy snow or icy conditions. The Model M is not designed for use in these types of conditions.
- Do not drive the Model M through water deeper than 1". Doing so may damage the components and make the Model M inoperable.
- Do not operate the Model M on soft surfaces such as sand or mud. Doing so may cause you to become stuck and unable to move the Model M.
- Do not use the Model M on slopes greater than 17% as the device may become unstable and tip over, resulting in damage and/or injury. The Model M has been tested for stability on 17% slopes (10 degrees) and should only be used on slopes less than 17%. For reference, a standard ramp with a railing going into a public building has an 8.3% slope.
- Do not use the Model M to navigate objects taller than 3". Doing so may cause the device to become unstable and tip over, resulting in damage and/or injury. The Model M is designed and tested for stability on obstacles less than 3" in height.
- Use extreme caution when driving on uneven surfaces or slopes. In these conditions the device may become unstable and tip over, resulting in damage and/or injury. It



USER MANUAL MODEL M

is recommended that you have someone available to stabilize the Model M if necessary when driving on uneven or sloped surfaces.

- Do not use the Model M as a seat during weight training. Doing so may cause the device to become unstable and tip over, resulting in damage and/or injury. The Model M is not intended to be used as a seat during weight training.
- For your safety, always fasten the lap belt when you are in the Model M. Failure to fasten the lap belt over your lap could result in injury if something occurs that causes you fall out of the chair.
- Only use seat cushions that have been certified to pass flammability testing.
- Do not change the seat cushions in the device without having your positioning evaluated by a seating technician. Failure to do so may result in injury due to improper positioning.
- To prevent injury to your legs or knees, you should inspect underneath tables or other objects before sliding the seat forward. Failure to do so may result in injury due to hitting objects with your legs or knees.
- Check that the tail lamps are working properly before operating the Model M at night or in low visibility conditions. Failure to check the tail lamps could result in injury if others cannot see the chair and collide with it.
- It is not safe to operate the Model M with the footplate in an up (vertical) position. Make sure the footplate is down before moving.
- Make sure your hands, arms, elbows and feet are inside the Model M when moving.
- Stopping distance on slopes can be significantly greater than on level ground.

Brake lock release

- Only disengage the brake locks (put the Model M in freewheel mode) for emergency and short-term use only. When the brake locks are released, the chair movement can only be stopped by external forces (a person or object). Failure to engage the brake locks may result in damage and/or injury if the chair moves uncontrollably.
- To prevent unintended movement, the Model M should be powered off whenever the brake locks are being engaged or disengaged. Failure to turn the power off may result in accidental chair movement, resulting in a collision and possible damage and/or injury.
- Do not use the Model M on a slope when the brake locks are disengaged (in freewheel mode). When the brake locks are released, the chair movement can only be stopped by external forces (a person or object). Failure to engage the brake locks when on a slope will make it extremely difficult to control or stop the Model M movement and could result in serious injury.



USER MANUAL MODEL M

Service

- The Model M contains no user-serviceable parts. Do not attempt to replace or repair any parts (including the batteries) on your own. Doing so may result in damage and/or injury. Service should only be done by a WHILL-authorized service representative.
- Do not spray water to clean off the Model M. Moisture may damage Model M components and make it inoperable.
- Do not attempt to adjust or modify the Model M. Doing so may damage the Model M. Adjusting or modifying the Model M may also make it less stable or impact its performance, resulting in injury if the chair tips over or is not controllable.

Transportation

If your device is not equipped with securement points for transportation:

- Do not let anyone sit in the wheelchair while in a moving vehicle.
- Transfer to the vehicle seat and use the vehicle-installed occupant restraint system.
- Make sure the brake releases are locked and secure the wheelchair so that it cannot roll or shift.
- Do not transport the wheelchair in the front seat of a vehicle. If it moves or shifts it can interfere with the driver.
- Any wheelchair that has been involved in a motor vehicle accident should not be used until inspected and tested by WHILL authorized service personnel. The structure or the wheelchair could be compromised or components broken that could make the wheelchair unsafe to operate or could otherwise injure you.

If your device has securement points:

- Please contact WHILL customer support with questions about using the wheelchair as a seat in a motor vehicle.
- The wheelchair must only be transported in a vehicle that is approved for such purposes.
- Only forward-facing use of the wheelchair in a motor vehicle is allowed.
- Only use the wheelchair in a motor vehicle as described in these instructions.
- Dynamic testing was conducted in a forward-facing wheelchair with a 172 lb crash test dummy restrained by both pelvic and shoulder belts. Both pelvic and shoulder belts should be used to reduce the possibility of head and chest impacts with vehicle components.
- Do not make any alterations to the wheelchair frame components or parts as these can compromise the device's transportability.
- Make sure the brake releases are locked and secure the wheelchair so that it cannot roll or shift



USER MANUAL MODEL M

- The lap belt is not designed for use as an occupant restraint when riding in a motor vehicle. To prevent damage and/or injury, you must use approved vehicle-anchored WTORS pelvic and shoulder belts. The lap belt present on the wheelchair may be used in addition to the vehicle-anchored occupant restraints as long as it does not interfere with the proper positioning of the WTORS.
- Both pelvic and shoulder belt restraints that comply with RESNA WC-4 Section 18, Wheelchair Tie-down and Occupant Restraint Systems For Use in Motor Vehicles should be used to limit occupant movement in a crash and reduce the likelihood of injury
- The WTORS that are used to secure the wheelchair to the vehicle and you to the vehicle (the occupant restraints) must be installed and attached in accordance with the manufacturer's instructions and RESNA WC-4 Section 18, Wheelchair Tie-down and Occupant Restraint Systems For Use in Motor Vehicles.
- Attach the WTORS only to the designated securement points on the wheelchair. Do not connect the WTORS to any other part of the wheelchair. Doing so may result in structural damage to the wheelchair.
- Attach the occupant restraints following the manufacturer's instructions and RESNA WC-4 Section 18, Wheelchair Tie-down and Occupant Restraint Systems For Use in Motor Vehicles.
- Any wheelchair-mounted accessories should be removed during transport and secured separately in order to reduce the chance they will break loose and injure vehicle occupants
- Sudden stops or motor vehicle accidents may damage your wheelchair. Do not use the wheelchair until inspected and tested by WHILL authorized service personnel. The structure or the wheelchair could be compromised or components broken that could make the wheelchair unsafe to operate or could otherwise injure you.
- Sufficient forward and rearward clear space should be provided around the wheelchair occupant. The forward clear zone must be larger when a shoulder-belt restraint is not used.
- Vehicle interior components that cannot be removed from the clear zones or that are near the occupant's space at a level that may come in contact with the occupant's head during a side-impact collision or vehicle roller, should be padded with a material that complies with Federal Motor Vehicle Safety Standard 201.

Battery Charging

- Read the instructions before attempting to use the battery charger.
- Only use the original battery charger provided with the Model M. Use of any other charger may cause damage or injury and will void the product's warranty. Please contact customer support if you need a replacement battery charger.



USER MANUAL MODEL M

- Battery charging should only be performed indoors. Exposing the battery charger to any moisture, water, or other elements may result in fire or electric shock.
- To reduce the risk of fire or electric shock, do not use extension cords with the battery charger. Use of extension cords may result in damage and/or injury.
- To reduce the risk of fire or electrical shock, do not leave the Model M plugged in and continuously charging for more than one week. Extended charging of the Model M may result in damage and/or injury.
- Keep the wheelchair and battery charger away from sources of ignition, such as flames and sparks, because the battery can generate explosive gasses while charging.
- Carry out charging with the wheelchair in a space at least twice its volume, with sufficient ventilation that there is no hazard due to build-up of flammable gas.
- Do not use the battery charger to charge other batteries.
- Do not carry the battery charger on the wheelchair.

Electromagnetic Interference

- Electromagnetic Interference (EMI) from external sources can impact braking and control of the Model M. Unintended brake release or Model M movement could result in serious injury. To prevent this:
 - DO NOT operate hand-held transceivers (transmitters/receivers), such as citizens band (CB) radios, or turn ON personal communication devices, such as cellular phones, while the powered Model M is turned ON;
 - Be aware of nearby transmitters, such as radio or TV stations, and try to avoid coming close to them;
 - If unintended movement or brake release occurs, turn the Model M OFF as soon as it is safe;
 - Be aware that adding accessories or components, or modifying the powered Model M, may make it more susceptible to EMI;
 - Report all incidents of unintended movement or brake release to the powered Model M manufacturer, and note whether there is a source of EMI nearby.

Section 6 of this user manual contains more information on EMI and how it can affect the Model M. To properly understand EMI, please read Section 6.



CAUTION

2.2 ***Cautions***

- Be sure to fully charge the batteries before any initial use of the Model M. Failure to charge the new batteries may reduce the overall battery life.
- To prevent the batteries from draining completely, charge the Model M at least once per month. If the batteries drain completely, do not use the Model M and have the batteries replaced as soon as possible.
- Be sure to check behind you for loose clothing or other material before moving the seat backwards. Failure to do so may result in items becoming caught in the seat slide rails. Gather up any objects and move them out of the way to ensure no damage is caused by seat movement.
- Reaching or leaning can affect the stability and balance of the Model M. To prevent injury, always exercise caution when shifting your weight or balance in the Model M. When in doubt, ask for help when reaching for inaccessible objects.
- The rear horizontal metal bar is available for you carry loads. Be sure that your weight plus the weight of the load does not exceed the wheelchair capacity. Also, be aware that carrying a heavy load may cause instability and harm.
- Removal of the rear access cover and extended exposure of the electrical parts and batteries underneath may cause serious damage to the wheelchair.
- To avoid injuries when the seat is backing up, do not stand on the seat slide track that is exposed when the seat is forward.
- Exercise caution when touching the omni wheels to avoid being pinched by the rollers.
- Do not park the wheelchair near external sources of heat that may harm the user or damage the wheelchair. Surface temperatures of the wheelchair can increase or decrease when exposed to external sources of heat or cold.

3 Product

3.1 Model M Components

Figure 1. Model M Components

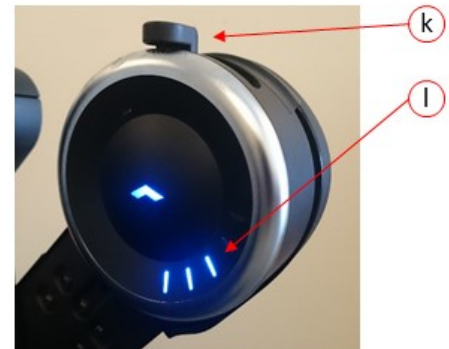



**USER MANUAL
MODEL M**

Table 1. Components as Labeled in Figure 1

a	Back Support Cushion	b	Directional Controller
c	Arm	d	Pressure relief handles
e	Seat Cushion	f	Foot Support
g	All Directional Wheel	h	Arm Support
i	Tail Lamp	j	Rear Tire
k	Mode Switch	l	Battery Indicator
m	Charger Port	n	Brake Release Lever

3.2 Arm and Seat Positions

The Model M arms and seat can each be in two different positions (Figure 2).

Figure 2. Model M Seat and Arm Positions



Arm Down/Seat Back Position

To drive the Model M, the arms must be locked in the down position and the seat moved all the way back



Arm Down/Seat Forward Position

Creates space to free your arms and allow for easier transfers

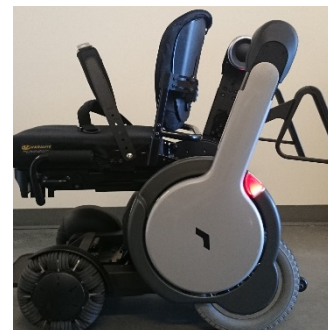

Arm Up/Seat Forward Position

Allows you to get closer to the edge of a table
Transfer is easier with the seat positioned forward

3.3 **Cushions**

The WHILL Model M is provided with a seat cushion. The seat base is compatible with seat cushions 16” wide and from 16” to 20” long. Please refer to the instruction manual provided with your cushion for warnings, maintenance, and use of the seat cushions.



WARNING

- Only use seat cushions that have been certified to pass flammability testing.
- Do not change the seat cushions in the device without having your positioning evaluated by a seating technician. Failure to do so may result in injury due to improper positioning.

3.4 **Specifications**

There is only one model of the Model M wheelchair, the specifications are listed below.

Table 2. Model M Specifications

Item	Specification
Drive System	4 Wheel Drive
Controller	WHILL Controlling System
Seat Sliding Range	5.9" (150mm)
Chair Ground Clearance	3.5" (89mm)
Maximum Speed	5.5 MPH (8.9 km/h)
Speed Settings	Fast, Medium, Slow Speed
Braking System	Electromagnetic Brake
Turning Radius	28" (711mm)
Maximum Weight Capacity	220lb (100kg)
Arm Angle (down position)	45, 48, 52, 56 degrees
Tail lamps (2)	Red lights
Batteries (2)	12V 50Ah (per battery)
Charger	6A_Charger Charging time: 8 hours to 80% charge
Foot Support Angle	0 to 10 degrees
Foot Support Extension	0", 1", 2", 3", 4" (0 mm, 25mm, 50mm, 75mm, 100mm)
Compatible Back Supports	VARILITE Icon back system - Low, Mid, Tall, Deep



**USER MANUAL
MODEL M**

Item	Specification
Compatible Seat Cushions	16" wide, from 16" to 20" deep
Operating Conditions	-13 to 122 degrees F (-25 to 50 degrees C)
Storage Conditions	-40 to 149 degrees F (-40 to 65 degrees C)

3.5 *Dimensional Information*

The RESNA standard (Section 15) requires disclosure of specification information in the format listed below.

Table 3. Model M Dimension

Item	Specification
Overall length	43" (1092mm) without feet 44.3" (1126mm) with feet
Overall width	23.7" (602mm)
Total mass (including batteries)	255 lb (115.7kg)
Pivot width	44.4" (1128mm) without feet 45.7" (1161mm) with feet
Required width of right angled corridor	35" (889mm) without feet 36.3" (922mm) with feet
Seat plane angle	4 to 14 degrees (4 positions)
Effective seat depth	16" to 20" (406.4 to 508mm) (5 positions)
Effective seat width	16" (406.4mm)
Seat surface height at front edge	20.2" to 22.2" (513.1 to 563.9mm) (3 positions)
Back support angle	10 to 20 degrees (4 positions)
Back support height	20" (508mm)
Foot support to seat	8.6" to 16.9" (218 to 429mm) (5 positions)
Leg to seat surface angle	104 degrees
Arm support height	8.5" to 10.5" (215 to 265mm) (6 positions)
Front location of arm support structure	10" (254mm)
Propelling wheel diameter and size including width	Diameter: 12.6" (320mm) Width: 2.25" (57.1mm)



Item	Specification
Horizontal location of axle	3" (75mm)
Static, impact and fatigue testing requirements	Pass
Resistance to ignition	Pass

3.6 Test Information

The RESNA standard (Section 15) requires disclosure of the performance test results. Some of the testing required the use of a test dummy. In all cases, the test dummy used weighed 220 lbs. The test methods used were as specified in RESNA WC-1 Section 15. The test data are summarized below

Table 4. Model M Performance Values

Test	Value
Static stability forward – drive wheels locked	16.3 ^o (lock-out) >20 ^o (full speed)
Static stability rearward – drive wheels locked	16.8 ^o (full speed)
Static stability anti-tip – drive wheels locked	17.6 ^o (full speed)
Maximum slope on which the chair remains upright after testing during all applicable tests	10 ^o
Maximum step/transition height across which wheelchair remains stable during all applicable tests	80.0 mm (3.1 in)
Running brakes – forward-reverse command stopping distance on level	57" (1448mm)
Continuous theoretical driving range	15.12 miles (24.33 km)
Maneuvering theoretical driving range	5.42 miles (8.72 km)
Maximum speed forward – horizontal surface	5.75 mph (2.57 m/s)
Maximum speed forward - 10 ^o inclined plane (maximum safe slope)	3.87 mph (1.73 m/s)
Climatic testing – rain, hot and cold operation and storage – pass/fail	Pass
Maximum obstacle height the chair can both climb and descend with technique used	3.1" (80.0mm): climb forward with run-up, descend casters trailing
Electrical systems – meets all requirements	Pass

Test	Value
Maximum thermal drive test results – total distance traveled uphill and reason for stopping test	1148.3 ft (350.0m) (chair drove for 60 minutes)
Non-powered mobility test – force required to start the loaded wheelchair moving in a straight line on the horizontal without electrical power	98N
Electromagnetic compatibility	Pass

4 Operation



WARNING

- Do not operate the Model M without first reading this user manual. Please pay close attention to all safety information and warnings. Contact customer support if you need any clarification on sections that are unclear. Failure to read and understand how to properly operate the Model M may result in damage and/or injury.
- Do not use the device if there are broken components as you could be injured by sharp edges or exposure to moving parts.
- Do not use the Model M if it has been exposed to excessive water, is damaged in any way, or requires service. Contact WHILL or reseller for service.

4.1 **Safety Check**



INFORMATION

Practice and get to know the feel of your device and its capabilities. Perform the safety checks listed below before each use to ensure your device will operate smoothly and safely.

Perform the following inspections before turning on the chair:

- Ensure the charger is unplugged from the Model M and that the charger, along with the cords, is safely stored away.
- Do not ride over the charger cable or connector as it could be damaged or entangled and may cause severe injury.

- Check the rear tires for signs of wear or damage. There should be no visible deformation of tires (they should be circular). The treads should not be worn out and there shouldn't be any unusual soft places on the tire.
- Check the front wheels for signs of wear or damage. The rubber on the rollers should not be worn out more than 3mm. The tire should not make any unusual noise when it spins.
- Check the device for physical damage such as dents, scratches, or corrosion. Awareness of the condition of your Model M will help improve the life and safety of the device.
- Check the arms to ensure they are locked in the down position.
- If you feel there is a service or maintenance problem or if any parts are worn or need replacement, contact WHILL customer support immediately.

4.2 ***Transfers into and out of the chair***



WARNING

- The weight capacity of the Model M is 220 lbs. To avoid injury or Model M failure, do not exceed this weight.



CAUTION

- Be sure to check behind you for loose clothing or other material before moving the seat backwards. Failure to do so may result in items becoming caught in the seat slide rails. Gather up any objects and move them out of the way to ensure no damage is caused by seat movement.
- To avoid injuries when the seat is backing up, do not stand on the seat slide track that is exposed when the seat is forward.



INFORMATION

- Transferring into or out of the device requires agility, awareness and extreme caution. Practice safe loading and unloading techniques and ask for assistance if you cannot transfer on your own.

The Model M has been designed to make transfers easy. The figures below demonstrate the steps that you may find useful during transfer:

Figure 3. Chair in the driving position.



Figure 4. Be sure the chair is on. If needed, turn on the chair by pulling the mode switch all the way towards you



Figure 5. With the mode switch in the “S” position, slide the seat forward using directional controller. Turn the chair off.



Figure 6. Lift/rotate the control arms up and backward.

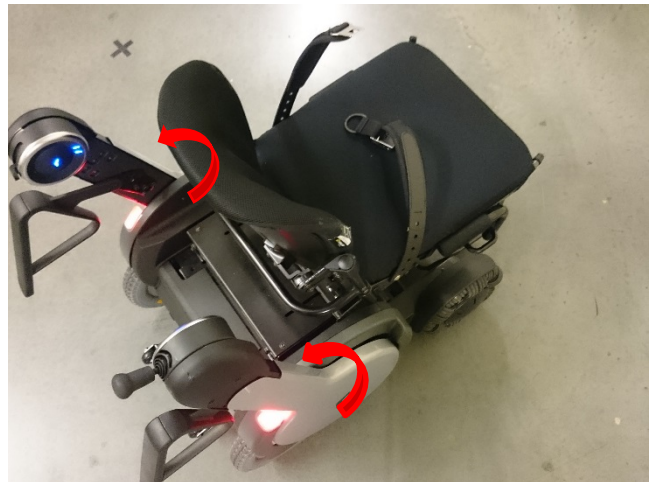

Figure 7. Pivot the footplate up out of the way if necessary. Transfer into the chair.



Figure 8. Lower the control arms to the down position.

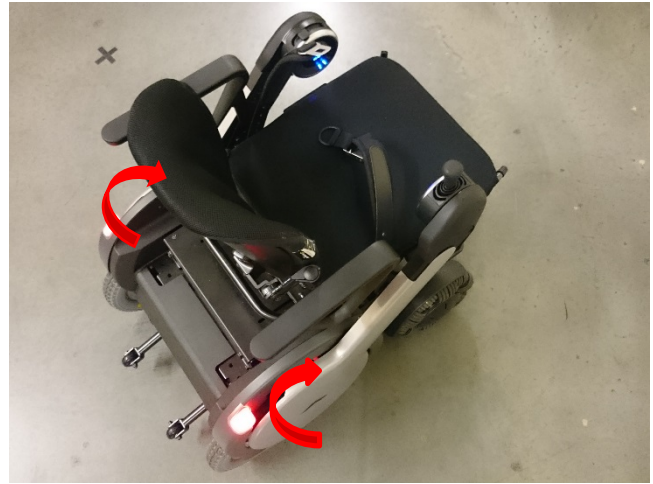
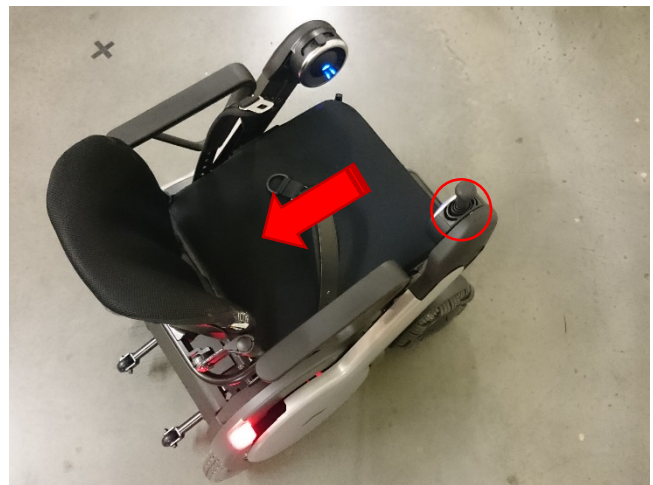

Figure 9. If footplate was pivoted up, return it to the horizontal position.



Figure 10. Turn the chair on then slide the seat backward using the directional controller.



Recommended practices when transferring into or out of the device include:

- Position the device so that the distance between it and the object from/to which you are transferring is close enough for your safe transfer.
- Use a transfer board if necessary.
- Put the device in seat mode and slide the seat forward.
- Turn the device off while transferring.

- Lift one or both of the controller arms to the upright position to gain more access to the seat.
- At any time, use the pressure relief handles at the base of the seat to help stabilize and position yourself.

If the seat will not or cannot move, do not transfer into or operate the device and contact WHILL customer support immediately. If you are seated in the device and find the seat unable to move, try to follow the same steps above to transfer out of the device safely without sliding the seat, and contact WHILL customer support immediately after you transfer out of the wheelchair.

Figure 11. Pressure relief handle locations.



4.3 *Lap Belt*



WARNING

For your safety, always fasten the lap belt when you are in the Model M. Failure to fasten the lap belt over your lap could result in injury if something occurs that causes you to fall out of the chair.

4.4 **Power Switch**

The power switch turns the chair on and off. Pull the switch towards you from the “S” (seat”) position to turn the power on or off. The switch is spring-loaded so it will return to the “S” position. When the power is on, the WHILL logo will light up (see Figure 12).

NOTE: Depending on the configuration of a left hand or right hand controller, the images may vary.

Figure 12. Power Switch; Illuminated LEDs mean the chair is on

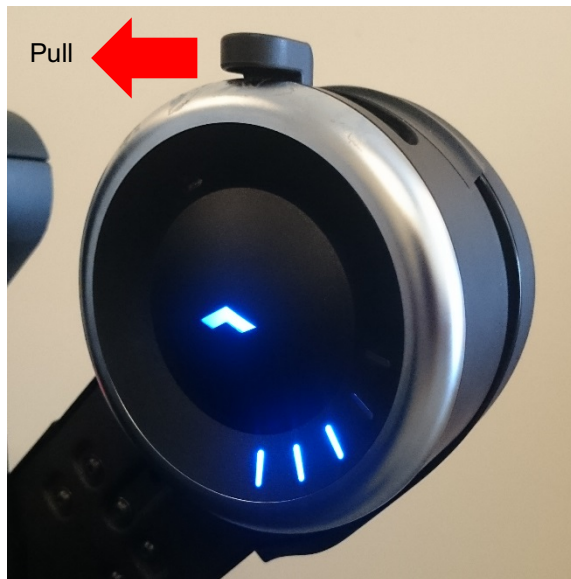

4.4.1 *Turning the Model M On*

- To turn on the Model M, pull the Mode Switch towards you once. The battery indicator blue light(s) should turn on for a second and the logo light should turn on and stay on.
- Around the power switch are multiple lights that indicate the amount of charge left in the battery. To understand the battery charge indicators, see section 4.5, Checking the Battery Charge Level.
-



INFORMATION

You should not touch the directional controller when you first turn on the Model M. The Model M has a short initialization cycle that will be interrupted if you move the directional controller when it is starting up. Doing so will result in an error code. If this occurs, turn off the Model M and then turn it back on, making sure not to touch the directional controller.

4.4.2 *Turning the Model M off*

To power off the Model M, pull the Mode Switch towards you once and the Model M will shut down.

If the power on/off does not behave as expected, refer to the Battery Charge section of this manual or contact WHILL customer support for help.

4.5 ***Checking the Battery Charge Level***

The battery charge is designed to last approximately 12 miles depending on conditions, such as road, driving conditions, temperature/humidity, payload and inclines. For more details see section 5.1, Battery Maintenance.

When the Model M is on, the blue lights indicate the amount of battery charge in the device. These 5 lights below the mode switch display the battery charge level. The lights will also indicate error conditions (see Section 8, Troubleshooting).

- If the device is losing charge too quickly, or if the lights indicate a wrong charge level, please contact WHILL customer support immediately.
- If the battery charge lasts significantly less than 12 miles, contact WHILL customer support immediately.

4.5.1 *Lights showing full battery charge*

When the Model M is on, a full battery charge is indicated by all 5 blue lights lighting up.

Figure 13. Lights indicating full battery charge.



4.5.2 *Lights showing intermediate charge level*

Figure 14. Two to four lights indicate an intermediate charge level.



4.5.3 *Low battery indication*

A low battery level (less than 37%) is indicated by one remaining blue light. If the one blue battery light changes to red and the logo light flashes, this means the Model M is on reserve battery charge (less than 20%) and you should charge the device immediately.

Figure 15. Lights indicating low and reserve battery charge levels

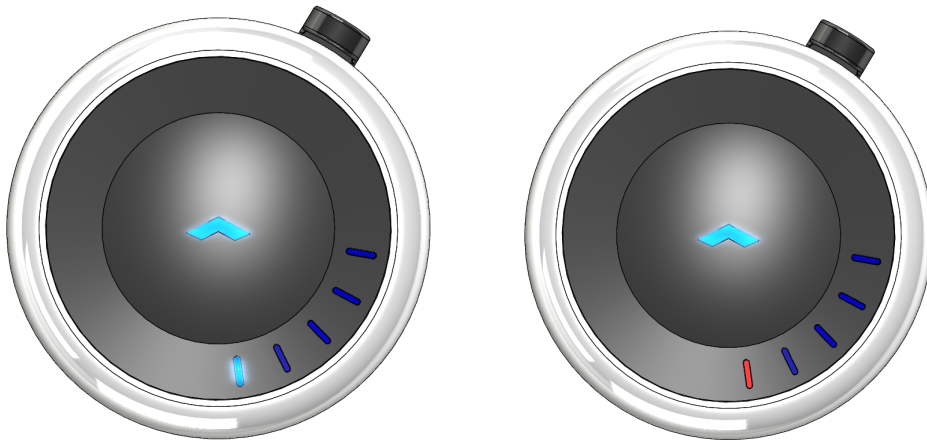

If the device stops due to a dead battery and there is no immediate charging available, refer to section 4.9, “Moving the device without power”.



INFORMATION

A red light and blue light in combination indicate an error code.

4.6 *Speed Control*

The operating speed is controlled by both the speed settings and directional controller. However, the directional controller must be used for the device to move in any direction at controlled speed.

4.6.1 *Speed Setting*

The default setting for the Mode Switch is marked with an S. In this mode, the directional controller will move the seat forward and backward, but there is no movement of the wheelchair. There are 3 speed settings that control the overall speed of the device. A label next to the switch indicates the speed setting (Figure 16). One arrow indicates low speed, a double arrow indicates medium speed, and a triple arrow indicates high speed.

Figure 16. Mode switch



4.6.2 *Speed control through the directional controller*

The speed can also be controlled by the amount of pressure you put on the directional controller. Unlike the speed setting, the directional controller provides continuous proportional variable speed control.

The speed adjustment using the directional controller is just like the accelerator pedal of a car: higher pressure makes the Model M go faster, while less pressure on the directional controller will make the Model M move more slowly.

When beginning to drive the Model M, always set the speed setting to slow (the setting closest to you) and apply just enough pressure on the directional controller for the device to begin moving.

4.7 ***Directional Controller***

The directional controller is the Model M's steering control. WHILL offers multiple shapes of directional controllers.

The directional controller is free to move in any direction. The figures below give some examples of the basic driving capabilities of your WHILL Model M. All of the possible driving configurations are not shown, but can be inferred from the drawings below.

Figure 17. To drive the chair straight forward or backwards (left figure) move the directional controller forward or back (right figure).



Move the

directional controller away from you to drive forward. Move it towards you to drive in reverse.

Figure 18. To turn to the right (left figure) move the directional controller at a diagonal (right figure).



Figure 19. To rotate to the right (left figure) move the directional controller directly to the right (right figure).



4.8 **Safety Check when Starting to Move**



INFORMATION

- It is recommended that you have someone with you the first time you use the Model M.
- In case of difficulty or problems, you should always have a cell phone or communication device with you when using the Model M.

When starting to operate the Model M:

- Make sure the Model M is turned on.
- Check that both rear tail lamps are on.
- Check the battery charge level: Make sure the Model M has enough charge in it to conduct your planned activities (see section 4.5 on Checking Battery Charge Level).
- Always start the Model M at the slowest speed setting (with the speed switch closest to you, Figure 20).

Figure 20. Mode switch placement for slow speed setting



- Push the directional controller very slowly in the direction you wish to move the Model M. You will feel the directional controller engaged when the device starts to move. Keep the speed switch at the slowest speed.
- Move to a safe open space and at the slowest speed with the controller, check that you can move in any direction you want.
- If you feel there are any new noises or vibrations, make note of these and report them to WHILL customer support.



INFORMATION

If the logo light is flashing (and the wheelchair is not in a low battery condition), this is an indication that the seat is not in the fully retracted position. You will have to move the seat backwards before driving the chair.

It is recommended that you leave the device in “S” mode when not driving the chair.

4.9 *Driving Conditions*

The Model M is designed with four wheel drive and should provide traction and stability in many conditions. However it is important to be aware of the limitations of the Model M. Note that if operating the Model M in low temperature conditions the battery capacity may be reduced and you may not be able to drive as far as in normal conditions. Other limitations are highlighted in Figure 21 and the warnings below.

Figure 21. Some key driving limitations

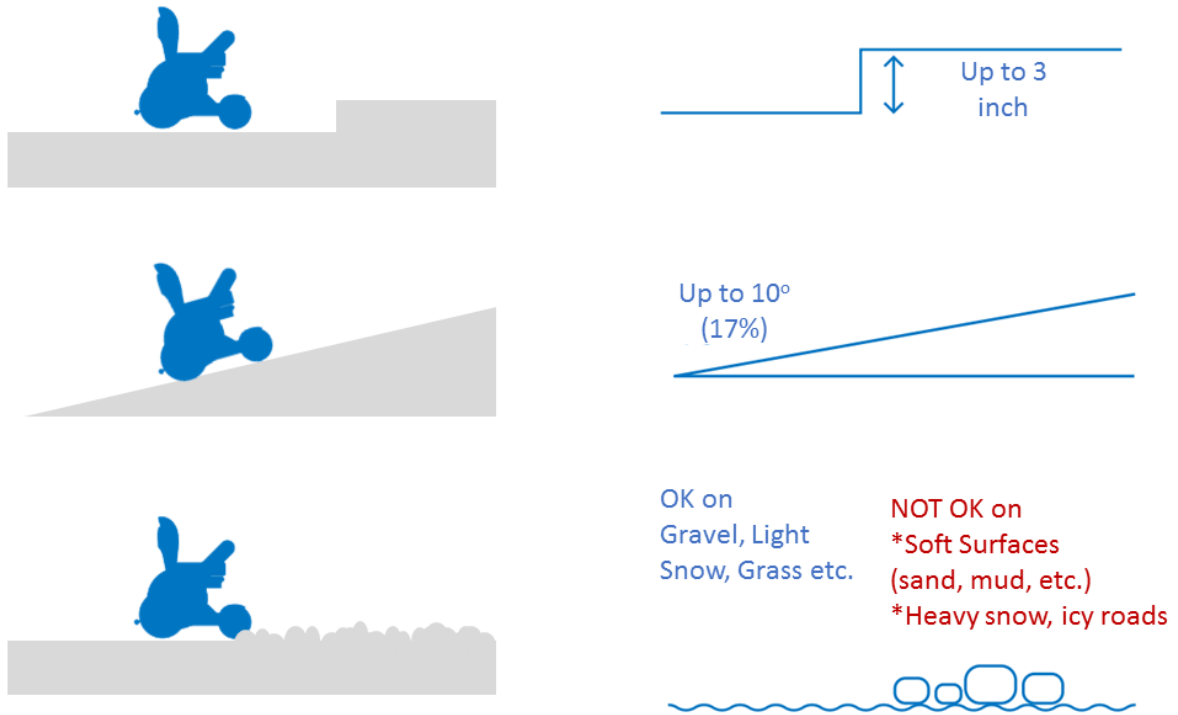

 **WARNING**

- Do not operate the Model M on any streets, roads, or highways. Operating the Model M on streets, roads, or highways may expose you to situations that may result in severe damage and/or injury. Before crossing the street, make sure that any and all drivers see you.
- To prevent injury and/or damage, do not use the Model M in heavy snow or icy conditions. The Model M is not designed for use in these types of conditions.
- Do not drive the Model M through water deeper than 1". Doing so may damage the Model M components and make the Model M inoperable.
- Do not operate the Model M on soft surfaces such as sand or mud. Doing so may cause you to become stuck and unable to move the Model M.
- Do not use the Model M on slopes greater than 17% as the device may become unstable and tip over, resulting in damage and/or injury. The Model M has been tested for stability on 17% slopes (10 degrees) and should only be used on slopes less than 17%. For reference, a standard ramp with a railing going into a public building has an 8.3% slope.



USER MANUAL MODEL M

- Do not use the Model M to navigate objects taller than 3". Doing so may cause the device to become unstable and tip over, resulting in damage and/or injury. The Model M is designed and tested for stability on obstacles less than 3" in height.
- Use extreme caution when driving on uneven surfaces or slopes. In these conditions, the device may become unstable and tip over, resulting in damage and/or injury. It is recommended that you have someone available to stabilize the Model M if necessary when driving on uneven or sloped surfaces.
- Do not use the Model M as a seat during weight training. Doing so may cause the device to become unstable and tip over, resulting in damage and/or injury. The Model M is not intended to be used as a seat during weight training.
- Check that the tail lamps are working properly before operating the Model M at night or in low visibility conditions. Failure to check the tail lamps could result in injury if others cannot see the chair and collide with it.
- It is not safe to operate the Model M with the footplate in an up (vertical) position. Make sure the footplate is down before moving.
- Make sure your hands, arms, elbows and feet are inside the Model M when moving.
- Stopping distance on slopes can be significantly greater than on level ground.



CAUTION

- Reaching or leaning can affect the stability and balance of the Model M. Always exercise caution when shifting your weight or balance in the Model M. When in doubt, ask for help when reaching for inaccessible objects.

In addition to the warnings and caution above, as depicted in Figure 22 to ensure a smooth and safe ride:

- Always approach curbs, thresholds, steps, and gradients straight-on
- Always approach obstacles, curbs, steps, and gradients at low speed

Figure 22. Approach all obstacles and slopes at a slow speed and straight on

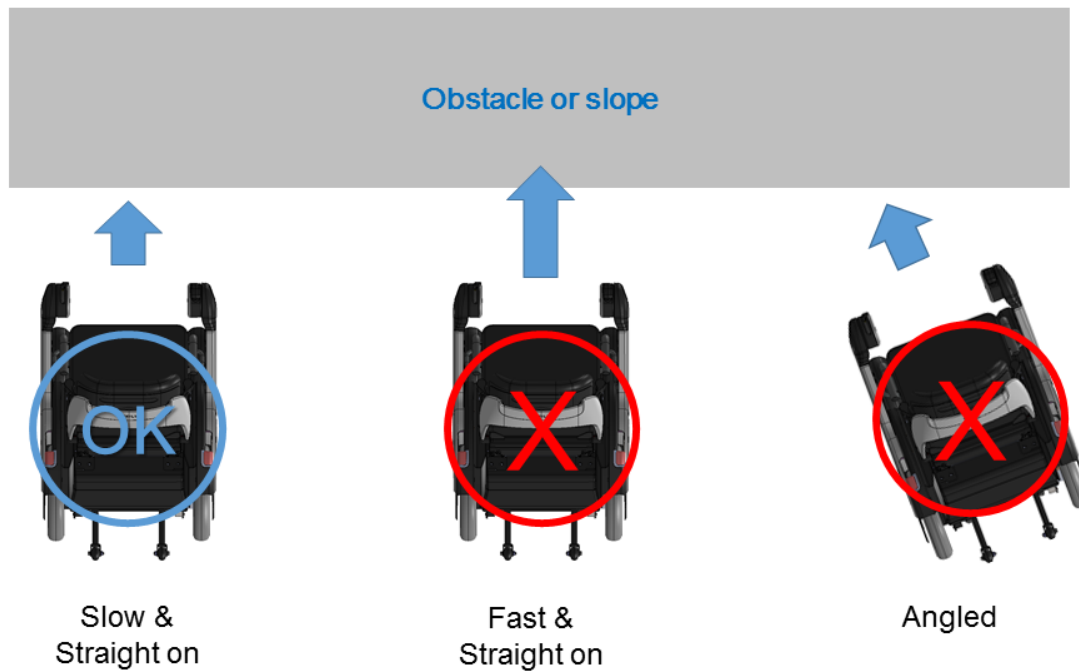

4.10 ***Stopping and Parking***

The Model M uses four wheel drive. This means that when the Model M is not powered (either because the power is turned off or because the directional controller is not in use), all the wheels are locked and will not move. You can power off the device and its brakes are automatically activated— no separate parking brake is needed.

4.11 ***Sitting at a Table or Desk***

Because the Model M has the unique feature of a sliding seat, you can position yourself at a table, desk or other object using the following steps:

- Position the Model M as close to the object as possible but not so close that the arm cannot be raised
- Lift both of the side arms to the upright position
- Put the Mode Switch into the S location and use the directional controller to extend the seat base forward
- Ensure the device is powered off
-



- To prevent injury to your legs or knees, inspect under tables or other objects before sliding the seat forward under them. Failure to do so may result in injury due to hitting objects with your legs or knees.

5 Brake Release Levers

This section describes how to use the Brake Release Levers. You may want to release the brakes and manually move the Model M when it is out of charge or otherwise inoperable. The Brake Release Levers disengage the electromagnetic brakes from the motors. This is called putting the Model M in “freewheel mode”. In freewheel mode there is no motor power to the Model M AND there are no brakes. The Model M will move freely. A Model M with one or both electromagnetic brakes released cannot be controlled using the directional controller, even when the device is turned on.

Note that if you have the Model M in freewheel mode and try to turn it on you will see an error code. This will occur with even one of the brakes released.



- Only disengage the brake locks (put the Model M in freewheel mode) for emergency and short-term use only. When the brake locks are released, the chair movement can only be stopped by external forces (a person or object). Failure to engage the brake locks may result in damage and/or injury if the chair moves uncontrollably.
- To prevent unintended movement, the Model M should be powered off whenever the brake locks are being engaged or disengaged. Failure to turn the power off may result in accidental device movement, resulting in a collision and possible damage and/or injury.
- Do not use the Model M on a slope when the brake locks are disengaged (in freewheel mode). When the brake locks are released, the chair movement can only be stopped by external forces (a person or object). Failure to engage the brake locks when on a slope will make it extremely difficult to control or stop the Model M movement and could result in serious injury.

Best practice when releasing the brakes:

- Keep in mind that the Model M will be difficult to control in freewheel mode.
- Be strongly aware of the environment around you, especially uneven surfaces, obstacles and people.

- Before releasing the electromagnetic brakes, use stopping devices such as chucks or stops to prevent the Model M from rolling away.
- Never park or transport a Model M that has a brake released.

5.1 ***How to release the electromagnetic brakes***

To release the electromagnetic brakes, use the following steps:

- The electromagnetic brake levers are located at the front of the chair, below the seat (Figure 23).
- Release each brake by pushing the lever down (see white arrow with unlock symbol) (Figure 24)

Figure 23. Placement of brake release levers on Model M



Figure 24. Close up of brake release lever



The electromagnetic brakes are now released and the Model M is free to roll. Have someone manually push the Model M forward or backwards and verify that it rolls freely.

5.2 ***How to engage the electromagnetic brake(s)***

To re-engage the electromagnetic brakes and enable Model M control, use the following steps:

- Look at the front of the Model M, below the seat, for the electromagnetic brake levers.
- Re-engage each brake by pulling the lever up (see blue arrow with lock symbol) (Figure 24).

Note that the lock symbol on the brake release labels has a “D” on it for “drive”.

The electromagnetic brakes are now engaged and the Model M will require battery power in order to move.

To test if the electromagnetic brakes are engaged, do the following:

- Check to see if someone can manually push the Model M. If it rolls, the electromagnetic brakes are not engaged.
- Turn on the Model M and check that no error code is displayed.
- Use the directional controller switch to move the Model M: it should move in all directions.

6 Battery and Charging

The Model M includes sealed lead-acid batteries and a High Power battery charger. These do not meet all the requirements of ISO 7176-25:2013 (the standard for safety of batteries and chargers for powered wheelchairs) however they passed testing equivalent to ISO 7176-25: 2013.

Before using your Model M for the first time, make sure you have fully charged the batteries for 10 hours. The battery charger will indicate when battery charging is complete and the wheelchair will indicate the battery charge level (see Section 4.4). It is recommended that the battery be fully charged before you use the Model M. Occasional use of the wheelchair prior to charging complete indication is acceptable if the need is urgent.

With a full battery charge you should be able to drive about 15 miles under ideal conditions. Factors that will affect the driving range include curves, terrain, driving habits, payload, and temperature. To get the maximum range or distance per charge, WHILL recommends the following:

- Always fully charge the batteries before a trip
- Reduce baggage weight as much as possible
- Avoid inclines and obstacles when planning your routes
- Maintain an even speed and avoid quick, frequent stops



WARNING

- Read the instructions before attempting to use the battery charger.
- Only use the original battery charger provided with the Model M. Use of any other charger may cause damage or injury and will void the product's warranty. Please contact customer support if you need a replacement battery charger.
- Battery charging should only be performed indoors. Exposing the battery charger to any moisture, water, or other elements may result in fire or electric shock.
- To reduce the risk of fire or electric shock, do not use extension cords with the battery charger. Use of extension cords may result in damage and/or injury.
- To reduce the risk of fire or electrical shock, do not leave the Model M plugged in and continuously charging for more than one week. Extended charging of the Model M may result in damage and/or injury.
- Keep the wheelchair and battery charger away from sources of ignition, such as flames and sparks, because the battery can generate explosive gasses while charging.

- Carry out charging with the wheelchair in a space at least twice its volume, with sufficient ventilation that there is no hazard due to build-up of flammable gas.
- Do not use the battery charger to charge other batteries.
- Do not carry the battery charger on the wheelchair.



CAUTION

- Be sure to fully charge the batteries before any initial use of the Model M. Failure to charge the new batteries may reduce the overall battery life.
- To prevent the batteries from draining completely, charge the Model M at least once per month. If the batteries drain completely, do not use the Model M and have the battery replaced as soon as possible.



INFORMATION

The batteries used are sealed valve-regulated lead-acid batteries. They do not require maintenance.

6.1 *Charger specifications for WHILL Model M*

Table 5. Charger specifications for Model M

Manufacturer	High Power
Model	HP0180WB 24V 6A
Charger Type	Off board
Input Voltage Range	AC 100~240V 50/60HZ
Output Current (DC)	6.0A ± 0.3A
Output Voltage (DC)	29.4V ± 0.3V
Pre-Charge Current	0.6A ± 0.3A
Constant Current Fast Charge	21V – 28V+1V/6A

Short Circuit Protection	YES
Protection Against Over Voltage	Automatically stops charging when output voltage is 5% over Vmax
Protection Against Over Current	Automatically stops charging when Output Current is 30% over rating current
LED Indicator	Power /On :RED Charging :Orange Full Charge :Green Protection: Red LED flash
Batteries types that can be charged	Sealed valve-regulated lead-acid batteries
Capacity of the batteries that can be charged (C₅)	42.5 Ampere hours (Ah)
Environmental protection rating	IPX1
Operating Temperature	0°C - 40°C
Operating Humidity	20% - 85%
Storage Temperature	-20°C -70°C
Use Below Altitude	2000m
Charging Connector Pin Assignment	1: DC Output +V (+29.4V) 2: DC Output -V (Ground) 3: INHIBIT
Dimensions	183mm (L) x 100mm (W) x 58mm (H)
Weight	0.81 kg

6.2 *Charging the battery*

Figure 25. Battery charger images and features



- ① AC cable receptacle
- ② Charging status indicator light
 - Green: fully charged (floating charge)
 - Orange: charging
 - Red: power on
 - Red LED flashing: protection
 - Off: disconnected
- ③ DC plug (into chair)
- ④ AC cable: not pictured, plugs into AC receptacle (1)

Please charge the Model M by following the steps below:

- Ensure the Model M is safely parked indoors in a well-ventilated room away from flames and sparks and has both its brakes engaged
- Turn off the Model M
- If not already done, connect the AC cable to the battery charger's AC receptacle ①
- Ensure the voltage of the wall outlet is 100 V to 240 V AC
- Connect the AC cable directly into a wall outlet. The LED status indicator ② on the charger will turn red when the power is on.

- Connect the round DC plug ③ to the charger port on the Model M (Figure 26). The LED status indicator on the charger will turn orange when it is charging.
- When the charging status indicator becomes a steady green light, the charging sequence has been completed.

Figure 26. Charger port



Depending on the condition of the battery, it may take about 10 hours to fully charge the batteries.

Note that if the Model M is turned on during charging, you will see an error code and will not be able to operate the Model M. In this case, unplug the charger before turning on the power.

To unplug the chair, remove the round DC plug from the chair, and remove the plug from the wall outlet. It is best to place the charger in a location where you are unlikely to run over it.

Charger Troubleshooting

If the red LED on the battery charger is flashing:

- Turn off the wheelchair and disconnect the charger's DC plug from the wheelchair.
- Unplug the charger from wall outlet for 5 seconds. This resets the charger.
- Plug the charger back into the wall outlet and turn it on.



If the battery charger does not appear to be on:

- Check the charging status light – if it is off, the charger may not be connected to AC power.
- Check to make sure there is power at the AC receptacle.

If you need to replace the battery charger, please contact WHILL customer support.

6.3 Battery service or replacement

To prevent problems, WHILL recommends battery replacement once a year. A weak battery or unusually short range per charge may be indicators of battery end of life. The batteries are designed to be serviced or replaced only by technicians qualified by WHILL. Please do not attempt to replace the batteries on your own. If you feel that the battery needs replacement, please contact WHILL customer support.

7 Electromagnetic Interference (EMI)

Powered wheelchairs may be susceptible to electromagnetic interference - a kind of interfering electromagnetic energy that is emitted from sources such as radio stations, TV stations, amateur radio (HAM) transmitters, two-way radios, and cellular phones. The interference from these radio wave sources can cause the wheelchair brakes to release, or the chair to move by itself or move in unintended directions. It can also permanently damage the chair's electronics and controls.



WARNING

- Electromagnetic Interference (EMI) from external sources can impact braking and control of the Model M. Unintended brake release or Model M movement could result in serious injury. To prevent this:
 - DO NOT operate hand-held transceivers (transmitters/receivers), such as citizens band (CB) radios, or turn on personal communication devices, such as cellular phones, while the Model M is turned ON;
 - Be aware of nearby transmitters, such as radio or TV stations, and try to avoid coming close to them;
 - If unintended movement or brake release occurs, turn the powered chair OFF as soon as it is safe;
 - Be aware that adding accessories or components, or modifying the powered chair may make it more susceptible to EMI

- Report all incidents of unintended movement or brake release to WHILL, and note whether there is a source of EMI nearby.

7.1 ***EMI Sources***

The sources of radiated EMI can be broadly classified into three types:

1. Hand-held compact transceivers (transmitters/receivers) with the antenna mounted directly on the transmitting unit. Examples include: citizens band (CB) radios, “walkie talkies”, security, fire and police transceivers, cellular telephones and other personal communication devices

Note: Some cellular telephones and similar devices transmit signals while they are ON, even when not being used.

2. Medium-Range mobile transceivers, such as those used in police cars, fire trucks, ambulances and taxis. These usually have the antenna mounted on the outside of the vehicle.
3. Long-Range transmitters and transceivers, such as commercial broadcast transmitters (radio and TV broadcast antenna towers) and amateur (HAM) radios.

Note: Other types of hand-held devices, such as cordless phones, laptop computers, AM/FM radios, TV sets, CD players, cassette players and small appliances such as electric shavers and hair dryers, so far as we know, are not likely to cause problems.

Because the emitted energy rapidly becomes more intense the closer one moves to the transmitting antenna (source), the electromagnetic fields from handheld radio sources (transceivers) are of special concern. It is possible to unintentionally bring high levels of electromagnetic energy very close to your chair’s control system while using these devices, and affect the chair’s movement and braking.

7.2 ***EMI Guidance Tables***

The following information was generated during testing that demonstrated device compliance with American National Standard For Wheelchairs - Volume 2, Additional Requirements For Wheelchairs (Including Scooters) With Electrical Systems Section 21: Requirements And Test Methods For Electromagnetic Compatibility Of Electrically Powered Wheelchairs And Motorized Scooters.

Table 6 Guidance and Manufacturer’s Declaration – Emissions

The Model M is intended for use in the electromagnetic environment specified below. The customer or user of the Model M should assure that it is used in such an environment.		
Emissions Test	Compliance	Electromagnetic Environment – Guidance
RF Emissions CISPR 11	Group 1	The Model M must emit electromagnetic energy in order to perform its intended function. Nearby electronic equipment may be affected.
RF Emissions CISPR 11	Class B	The Model M is suitable for use in all establishments, including domestic establishments and those directly connected to the public low voltage power supply network that supplies buildings used for domestic purposes.
Harmonics EN 61000-3-2	Class A	
Flicker EN 61000-3-3	Complies	
RF emissions CISPR 14-1	Not applicable	The Model M is not suitable for interconnection with other equipment
RF emissions CISPR 15	Not applicable	The Model M is not suitable for interconnection with other equipment

Table 7 Guidance and Manufacturer’s Declaration – Immunity

The Model M is intended for use in the electromagnetic environment specified below. The customer or user of the Model M should assure that it is used in such an environment.			
Immunity Test	IEC 60601 Test Level	Compliance Level	Electromagnetic Environment – Guidance
Electrostatic Discharge (ESD) IEC 61000-4-2	±6kV Contact ±8kV Air	±6kV Contact ±8kV Air ±8kV Charged	Floors should be wood, concrete or ceramic tile. If floors are synthetic, the r/h should be at least 30%
Electrical fast transient/burst IEC 61000-4-4	±2kV for power supply lines ±1kV for input/output lines	±2kV for power supply lines ±1kV for input/output lines	Mains power quality should be that of a typical commercial or hospital environment.
Surge IEC 61000-4-5	±1kV line(s) to line(s) ±2kV line(s) to earth	±1kV line(s) to line(s) ±2kV line(s) to earth	Mains power quality should be that of a typical commercial or hospital environment.

Voltage dips, short interruptions and voltage variations on power supply input lines IEC 61000-4-11	>95% Dip for 0.5 Cycle 60% Dip for 5 Cycles 30% Dip for 25 Cycles >95% Dip for 5 Seconds	100% Dip for 0.5 Cycle 60% Dip for 5 Cycles 30% Dip for 25 Cycles 100% Dip for 5 Seconds	Mains power quality should be that of a typical commercial or hospital environment. If the user of the Model M requires continued operation during power mains interruptions, it is recommended that the Model M be powered from an uninterruptible power supply or battery.
Power Frequency (50/60Hz) Magnetic Field IEC 61000-4-8	3A/m	30 A/m (>3A/m)	Power frequency magnetic fields should be that of a typical commercial or hospital environment.

Table 8 Guidance and Manufacturer’s Declaration – Immunity

The Model M is intended for use in the electromagnetic environment specified below. The customer or user of the Model M should assure that it is used in such an environment.			
Immunity Test	IEC 60601 Test Level	Compliance Level	Electromagnetic Environment – Guidance
Conducted RF IEC 61000-4-6	3 Vrms 150 kHz to 80 MHz	3 Vrms (=V1) 150 kHz to 80 MHz	Portable and mobile RF communications equipment should be used no closer to any part of the Model M, including cables, than the recommended separation distance calculated from the equation applicable to the frequency of the transmitter. Recommended separation distance $D = \left(\frac{3.5}{V1}\right) \sqrt{P}$ 150kHz to 80MHz
Radiated RF IEC 61000-4-3	3 V/m 80 MHz to 2.5 GHz	20 V/m 26 MHz to 3 GHz	$D = \left(\frac{3.5}{E1}\right) \sqrt{P}$ 80 to 800 MHz

		(>3V/m=E1)	$D = \left(\frac{7}{E1}\right)\sqrt{P}$ <p>800 MHz to 2.5 GHz</p> <p>where P is the max power in watts and D is the recommended separation distance in meters.</p> <p>Field strengths from fixed transmitters, as determined by an electromagnetic site survey, should be less than the compliance levels (V1 and E1).</p> <p>Interference may occur in the vicinity of equipment marked with the following symbol.</p> 
--	--	------------	---

Table 9 Recommended separation distances between portable and mobile RF communications equipment and Model M

The Model M is intended for use in the electromagnetic environment in which radiated disturbances are controlled. The customer or user of the Model M can help prevent electromagnetic interference by maintaining a minimum distance between portable and mobile RF Communications Equipment and the Model M as recommended below, according to the maximum output power of the communications equipment.

Rated maximum output power of transmitter (Watts)	Separation distance according to frequency of transmitter (m)		
	150kHz to 80MHz	80 to 800MHz	800MHz to 2.5GHz
	$d = \left(\frac{3.5}{V1}\right)\sqrt{P}$	$d = \left(\frac{3.5}{E1}\right)\sqrt{P}$	$d = \left(\frac{7}{E1}\right)\sqrt{P}$
0.01	0.12	0.12	0.23
0.1	0.38	0.38	0.73
1	1.2	1.2	2.3
10	3.8	3.8	7.3
100	12	12	23

For transmitters rated at a maximum output power not listed above, the recommended separation distance d in meters (m) can be estimated using the equation applicable to the



**USER MANUAL
MODEL M**

frequency of the transmitter, where P is the maximum output power rating of the transmitter in watts (W) according to the transmitter manufacturer.

NOTE 1: At 80 MHz and 800 MHz, the separation distance for the higher frequency range applies.

NOTE 2: These guidelines may not apply in all situations. Electromagnetic propagation is affected by absorption and reflection from structures, objects, and people.

8 Troubleshooting

If only one indicator light is on and it is not the light for low battery indicator, then it is an error code.

Error codes may be caused by:

- Trying to move the Model M with the seat in a forward slide position.
- Turning on the Model M and trying to move it while the charger is plugged in.
- Touching the directional controller when you first turn on the Model M and it is starting up.
- One or both of the brakes are released when you turn on the Model M.

When you encounter an error code you should restart the chair. If that does not solve the problem, please contact your distributor or WHILL customer support for assistance.

Whenever you turn on the Model M, all the battery indicator lights should illuminate, enabling you to see if they are all operational.

9 Maintenance



WARNING

- The Model M contains no user-serviceable parts. Do not attempt to replace or repair any parts (including the batteries). Doing so may result in damage and/or injury. Service should only be done by a WHILL-authorized service representative.
- Do not attempt to adjust or modify the Model M. Doing so may damage the Model M. Adjusting or modifying the Model M may also make it less stable or impact its performance, resulting in injury if the chair tips over or is not controllable.
- Do not spray water to clean off the Model M. Moisture may damage the Model M components and make it inoperable.

There is no service manual available to you for the WHILL Model M.

To clean the Model M, wipe it with a soft cloth or with an anti-bacterial wipe. Never spray liquid directly on to the Model M as it could get inside the device and cause damage.

It is recommended that users take the Model M to a WHILL-authorized reseller or WHILL-authorized service technician for an annual safety inspection of the device including general wear and tear of seating and tires.

10 Transport Option

Determine if your wheelchair has the optional tie downs (securement points) installed. To do this, look for the transportation symbol (Figure 27) on the back of the device, below the seat (Figure 28).

Figure 27. RESNA WC-4 Section 19 transportation symbol



The symbol indicates that the wheelchair has been tested for transportability and is in compliance with RESNA WC-4 Section 19, Wheelchairs used as seats in motor vehicles.

Figure 28. Rear view of wheelchair showing transportation sticker and tie downs



If the tie downs have not been installed on your wheelchair you will not see the symbol and you should never sit in the wheelchair when in a motor vehicle. The following warnings apply:

 **WARNING**

- Do not let anyone sit in the wheelchair while in a moving vehicle.
- Transfer to the vehicle seat and use the vehicle-installed occupant restraint system.
- Make sure the brake releases are locked and secure the wheelchair so that it cannot roll or shift.

- Do not transport the wheelchair in the front seat of a vehicle. If it moves or shifts it can interfere with the driver.
- Any wheelchair that has been involved in a motor vehicle accident should not be used until inspected and tested by WHILL authorized service personnel. The structure or the wheelchair could be compromised or components broken that could make the wheelchair unsafe to operate or could otherwise injure you.

10.1 *Using the Transport Option*

This section only applies to wheelchairs that have the optional tie downs installed. If the transport symbol is present on the wheelchair the four tie downs have been installed on the device and it can be used as a seat in a vehicle. In the descriptions that follow, the person in the wheelchair in a vehicle is referred to as the “occupant”.

NOTE: WHILL does not offer Wheelchair Tie-down and Occupant Restraint Systems (WTORS). You should purchase WTORS that are compliant with RESNA WC-4 Section 18, Wheelchair Tie-down and Occupant Restraint Systems For Use in Motor Vehicles from your wheelchair distributor.

The following warnings apply:



WARNING

- Please contact WHILL customer support with questions about using the wheelchair as a seat in a motor vehicle.
- The wheelchair must only be transported in a vehicle that is approved for such purposes.
- Only forward-facing use of the wheelchair in a motor vehicle is allowed.
- Only use the wheelchair in a motor vehicle as described in these instructions.
- Dynamic testing was conducted in a forward-facing wheelchair with a 172 lb crash test dummy restrained by both pelvic and shoulder belts. Both pelvic and shoulder belts should be used to reduce the possibility of head and chest impacts with vehicle components.
- Make sure the brake releases are locked and secure the wheelchair so that it cannot roll or shift
- Do not make any alterations to the wheelchair frame components or parts as these can compromise the device’s transportability.
- The lap belt is not designed for use as an occupant restraint when riding in a motor vehicle. To prevent damage and/or injury, you must use approved vehicle-anchored WTORS pelvic and shoulder belts. The lap belt present on the wheelchair may be used



USER MANUAL MODEL M

in addition to the vehicle-anchored occupant restraints as long as it does not interfere with the proper positioning of the WTORS.

- Both pelvic and shoulder belt restraints that comply with RESNA WC-4 Section 18, Wheelchair Tie-down and Occupant Restraint Systems For Use in Motor Vehicles should be used to limit occupant movement in a crash and reduce the likelihood of injury
- The WTORS that are used to secure the wheelchair to the vehicle and you to the vehicle (the occupant restraints) must be installed and attached in accordance with the manufacturer's instructions and RESNA WC-4 Section 18, Wheelchair Tie-down and Occupant Restraint Systems For Use in Motor Vehicles.
- Attach the WTORS only to the designated securement points on the wheelchair. Do not connect the WTORS to any other part of the wheelchair. Doing so may result in structural damage to the wheelchair.
- Any wheelchair-mounted accessories should be removed during transport and secured separately in order to reduce the chance they will break loose and injure vehicle occupants
- Sudden stops or motor vehicle accidents may damage your wheelchair. Do not use the wheelchair until inspected and tested by WHILL authorized service personnel. The structure or the wheelchair could be compromised or components broken that could make the wheelchair unsafe to operate or could otherwise injure you.

Whenever feasible, people who use wheelchairs should transfer to the vehicle seat and use the vehicle-installed, occupant restraint system.

The wheelchair must be secured into position by attaching the straps to the four tie down bars. There are two securement points at the back of the chair (Figure 28) and one on each side of the seat near the pressure relief handle (Figure 29).

Figure 29. Front tie down point



Each tie down is identified with the hook gage symbol:

Figure 30. Tie down point marking



10.2 *Proper Occupant Restraint*

The wheelchair provides for anchoring a pelvic-belt restraint that conforms with the requirements of RESNA WC-4 Section 19, Wheelchairs used as seats in motor vehicles and can be used in conjunction with a vehicle-anchored shoulder belt with standard lower-anchorage connector as a crashworthy three-point-belt restraint in motor vehicles.

The angle of the pelvic-belt restraint should be between 30 and 75 degrees relative to the horizontal and, ideally, between 45 and 75 degrees relative to the horizontal (Figure 31).

Figure 31. Preferred angles for pelvic belt restraint

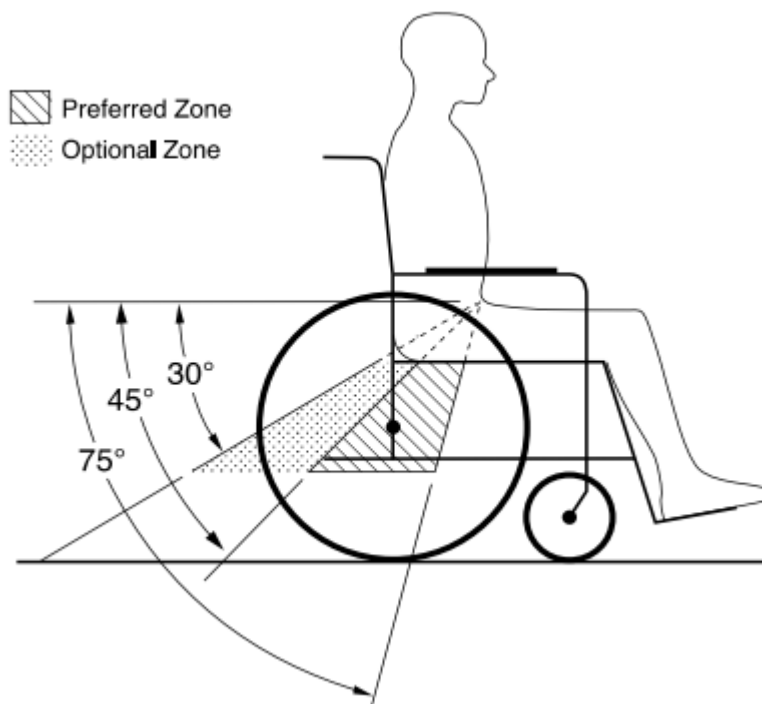

Steeper side-view pelvic belt angles are especially important if the pelvic belt is intended to be used for postural support in addition to occupant restraint in a frontal crash. Steeper angles will reduce the tendency for a vertical gap to develop between the user and the belt due to compliance of seat cushions and belt movement, thereby reducing the tendency for the user to slip under the belt and for the belt to ride up on the soft abdomen during normal use.

Steeper belt angles also reduce the tendency for upper-torso belts to pull the pelvic belt onto the abdomen during frontal impact loading.

For proper positioning:

- Belt restraints should not be routed outside of the wheelchair or over the wheelchair arm supports and should not be held away from the body by wheelchair components or parts (Figure 32).
- The belt restraint buckle of three-point belt restraints must be placed in contact with the occupant's body and away from wheelchair components.
- Upper-torso belt restraints should fit directly over, and be in contact with the middle of the shoulder (Figure 33).
- The junction of the shoulder belt and pelvic belt of three-point belts should be located near the hip opposite to the shoulder over which the diagonal belt crosses and not near the midline of the occupant.
- Belt restraints should be adjusted as snugly as possible, consistent with user comfort.
- Belt restraints should not be worn or twisted in a manner that reduces the area of contact of the belt webbing with the occupant.

Figure 32. Do not place the belt restraints on the outside of the arms or wheels



Figure 33. Pelvic belt restraints should make good contact with the front and sides of the body near the junctions of the thighs and pelvis and against the hips

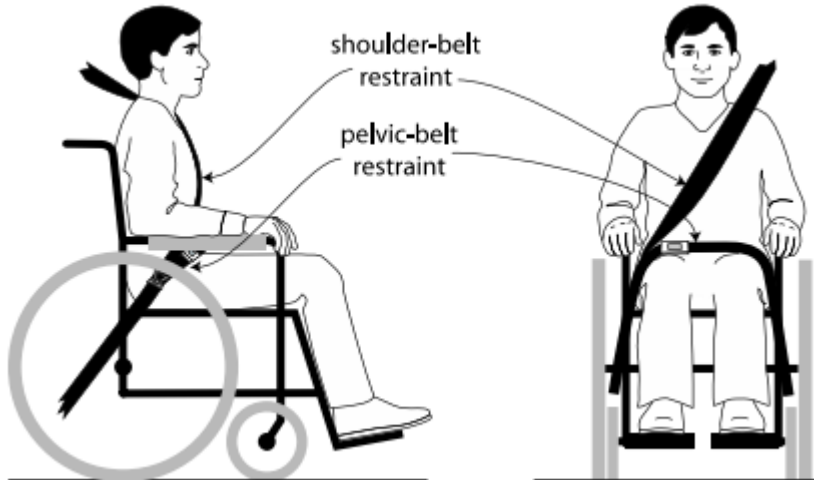

10.3 *Clear Zones*

Clear (or clear-space) zones indicate the safe areas around the front and back of a secured wheelchair. The recommended front clear zone (FCZ) is 26" (measured from the front of the occupant's head) if the occupant is restrained by both pelvic and shoulder belts and 37" inches if only a pelvic restraint is used (Figure 34 and Figure 35). It is understood that the frontal (or forward) clearance zone (FCZ) may not be achievable for wheelchair-seated drivers. The rear clear zone is 16" measured from the back of the occupant's head.

Figure 34. Top view of recommended front and rear clear zones (numbers in inches)

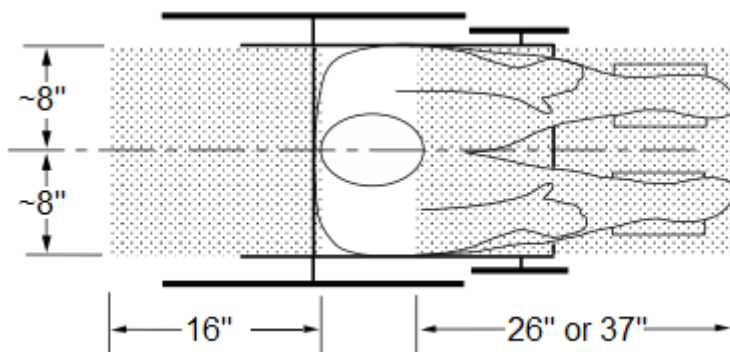
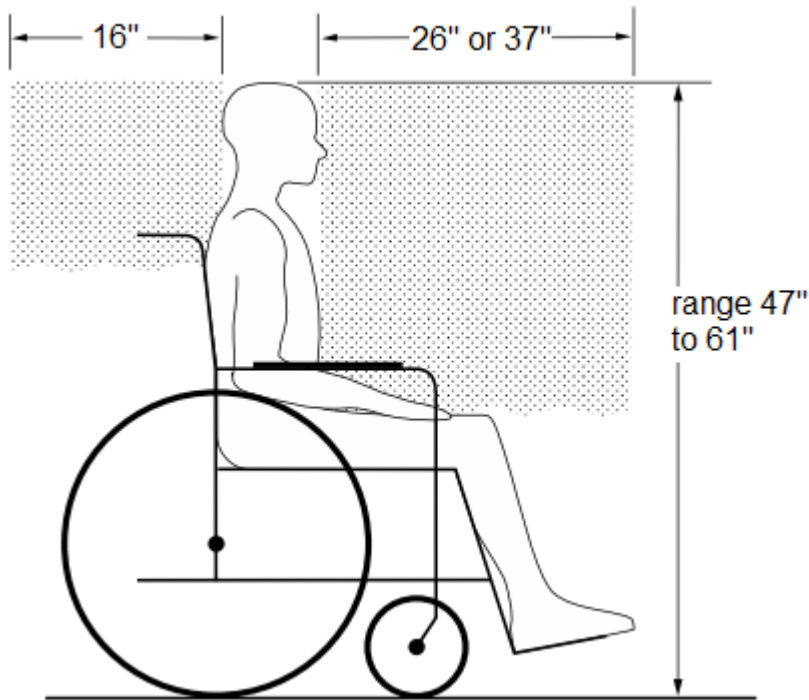

Figure 35. Side view of recommended front and rear clear zones (numbers in inches)



The seated head height is estimated to range from 47" for a small adult female to 61" for a tall adult male.

The following warnings are related to clearance zones:











 **WARNING**







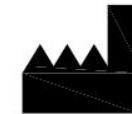

- Only forward-facing use of the wheelchair in a motor vehicle is allowed.
- Sufficient forward and rearward clear space should be provided around the wheelchair occupant (Figure 34 and Figure 35). The FCZ must be larger when a shoulder-belt restraint is not used.
- Vehicle interior components that cannot be removed from the clear zones or that are near the occupant's space at a level that may come in contact with the occupant's head during a side-impact collision or vehicle rollover, should be padded with a material that complies with Federal Motor Vehicle Safety Standard 201.





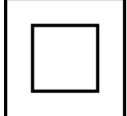

It is strongly recommended that both pelvic and shoulder belts be used by the wheelchair occupant.

11 Symbols

The following symbols can be found on the device or the device packaging.

Symbol	Meaning
	Warning. Indicates a hazardous situation that, if not avoided, could result in death or serious injury.
	Caution. Indicates a hazardous situation that, if not avoided, may result in property damage, minor injury, or both.
	Information. Gives useful tips, recommendations and information for efficient, trouble-free use.
	Power on/off
	Seat mode
	Low speed
	Medium speed
	High speed
	Catalog/model number
	Serial number
	Manufacturer

	<p>Caution. Indicates the need for the user to consult the instructions for use for important cautionary information such as warnings and precautions not presented on the medical device itself.</p>
	<p>Consult Instructions for Use</p>
	<p>CAUTION: Federal (USA) law restricts this device to sale by or on the order of a physician.</p>
	<p>Dispose of this equipment according to local regulations for electrical and electronic waste disposal</p>
	<p>Brake release is locked</p>
	<p>Brake release is unlocked</p>
	<p>Indoor use only</p>
	<p>IEC 61140 Class II electrical appliance. The product is double insulated and does not require a safety connection to electrical earth.</p>
	<p>Temperature limits within which the shipping package shall be stored and handled</p>
	<p>Humidity limits within which the transport package shall be stored and handled</p>

	<p>Shipping package shall be kept in an upright position</p>
	<p>Stacking of the shipping package is not allowed and no load should be placed on the package</p>
	<p>Contents of the shipping package are fragile therefore it shall be handled with care</p>
	<p>Shipping package shall be kept away from rain</p>
	<p>Surface unsuitable to sit on</p>
	<p>Surface unsuitable for stepping onto</p>



**USER MANUAL
MODEL M**



12 Warranty

WHILL, Inc. (WHILL) personal mobility and wheelchair products (“**Product**”) are warranted against defects in materials and workmanship as follows, for a period from the date of your receipt of the Product from WHILL or a WHILL-authorized third-party distributor or reseller equal to the following: (i) with respect to the base and seat frame, five (5) years, and (ii) with respect to the seat and back cushion, two (2) years, and (iii) with respect to the electrical and mechanical components, one (1) years, and (iiii) with respect to the batteries and tires, six (6) months (“**Warranty Period**”) in each case when used in accordance with the applicable usage documentation. If a defect arises during the Warranty Period, WHILL will, at its option: (a) provide replacement parts that are new and/or previously used parts that are equivalent to new in performance and reliability to the defective parts or, with your consent, are at least functionally equivalent to the parts they replace; or (b) exchange the affected Product with a functionally equivalent Product that is new or formed from new and/or previously used parts that are equivalent to in performance and reliability or, with your consent, a Product that is at least functionally equivalent to the Product it replaces.

This warranty excludes: (i) normal depletion of consumable and/or wearable parts (such as trim components and covers for the seat and back cushion) unless failure has occurred due to a defect in materials or workmanship; and (ii) damage resulting from abuse, accident, modifications, unauthorized repairs, or other causes that are not defects in materials and workmanship.

Further this warranty does not cover any labor costs that may be incurred in connection with installation or repair of your Product. The Product is sold primarily through third-party distributors and/or resellers, which provide warranty repair services to WHILL customers, who may or may not charge fees for their repair labor under separate terms and conditions. In the event the distributor or reseller is no longer in business or has ceased to sell WHILL products, WHILL will provide a list of authorized repair companies. Please contact WHILL to obtain a current list of authorized repair companies.

This warranty is valid solely for customers who purchased their Product directly from WHILL or a WHILL-authorized third-party distributor or reseller in the United States and Puerto Rico.

Some states and countries do not allow limitations on how long such warranties, conditions, and/or implied terms may last, so the limitation described above may not apply to you. This warranty is offered in addition to rights and remedies conveyed by consumer protection laws and regulations that cannot be statutorily waived, and does not affect your applicable statutory rights.

No person other than WHILL is authorized to modify this limited product warranty.



13 Customer Support

For any questions or concerns, please contact WHILL, Inc. Customer Support

Email: support@whill.us

Telephone: (844) 699-4455

Address: 285 Old County Rd # 6, San Carlos, CA 94070



WHILL

WHILL, Inc.

285 Old County Rd. #6 San Carlos, CA 94070

844-MYWHILL (844-699-4455)

www.whill.us